



# HEALTHCARE SECTOR

February 2023



Issue No. 01

## Table of Content

<b>General Design Considerations</b>	<b>4</b>
<b>Fire Safety</b>	<b>5</b>
<b>Acoustics</b>	<b>6</b>
<b>Structure</b>	<b>9</b>
<b>Service Integration</b>	<b>11</b>
<b>Sector Focus</b>	<b>13</b>
<b>Robustness</b>	<b>13</b>
<b>Visual Aesthetics</b>	<b>13</b>
<b>Speech Clarity</b>	<b>14</b>
<b>Versatility</b>	<b>18</b>
<b>Solution Selection</b>	<b>19</b>
<b>Partitions</b>	<b>20</b>
<b>Shaftwall Solutions</b>	<b>30</b>
<b>Wall Linings</b>	<b>31</b>
<b>Monolithic Ceiling</b>	<b>33</b>
<b>Exterior Envelop</b>	<b>35</b>
<b>Sector Specified Details</b>	<b>36</b>
<b>Finishing and Accessories</b>	<b>39</b>



Technology  
innovation  
cycles are  
exponential.

## Introduction



**01**

Group  
Visits



**02**

Team  
Approach



**03**

Artificial  
Intelligence



**04**

Virtual Reality



**05**

Healthcare  
Trackers



**06**

Personalized  
Healthcare



**07**

Genome  
Sequencing



**08**

Drug  
Development



**09**

Nanotechnology



**10**

3D Printing



**11**

Robotics

Technology will cause a significant shift in healthcare. Technology innovation cycles are exponential. This implies that by 2040, the healthcare industry will see significant changes.

The current state of healthcare is institutionalized. Healthcare will be able to be individualized with ease thanks to artificial intelligence, data, interoperable devices, wearable technologies, and similar innovations. Customers will figuratively take healthcare into their own hands by providing data and information to benefit from individualized wellness programs.

The first locations that usually come to mind when you think of doctors and healthcare are probably packed doctor's offices and hospitals. However, technology is also transforming how healthcare is delivered.

There will be creative ways to link healthcare specialists with individuals who need care, including virtual communities, health hubs, and special care operators.

Here are some significant predictions about future healthcare developments that are at the cutting edge of technology:

### Online Visits

Online doctor appointments have increased dramatically as a result of video conferencing. Online visits have replaced house calls in emergencies where patients cannot get to the doctor. The ease of internet consultations also makes doctors more accessible to patients in remote locations without access to healthcare.

### Group Visits

The need for physicians rises as the population grows. What should we do if the supply cannot keep up? Visits with groups are growing in popularity. When several patients with comparable symptoms are seen by doctors at the same time, this is known as a group visit. Patients who have similar chronic diseases, such as diabetes, are also likely to attend group sessions. On the plus side, this can connect those in like circumstances so they can get to know one another and attempt to handle their difficulties jointly.

### Team Approach

Providers may use a collaborative approach to therapy to improve healthcare. To manage a patient and meet all of their demands from many angles, clinicians from different levels and specialties collaborate. The collaborative approach centers the patient and counts on each professional to share their expertise to provide the best possible treatment.

## Introduction *(continued)*

### Artificial Intelligence

The use of artificial intelligence in healthcare will continue to grow. Deep learning is one example of how AI is being used in the medical field. Robots may then utilize data to learn from various scenarios and react accordingly without interacting with humans. Real-time diagnosis and even prescription writing have been handled by AI in the medical industry. Robots will also be utilized to help medical staff with practical duties, such as bringing goods into a hospital from the kitchen or stock rooms, for example.

### Virtual Reality

Virtual reality has various applications in the healthcare industry. Imagine a pediatric unit where a little child is experiencing agony. By donning a virtual reality headset, they may retreat into a pain-relieving virtual haven. Before a student becomes a doctor and enters the operating room, they can practice in a surgical scenario using virtual reality in medical school.

### Healthcare Trackers, Wearables, And Sensors

Technology and data are essential to customizing healthcare. People may now take charge of their own health and fitness thanks to new healthcare trackers like the Apple Watch and diabetes sensors like the Dexcom. Patients may readily exchange health information with their doctors to aid in the diagnosis and prevention of issues, including controlling their weight, stress levels, and blood sugar.

### Personalized Healthcare

Predictive medicine is one of the largest improvements in healthcare. Professionals may access healthcare data from smart gadgets and devices to anticipate issues before they even materialize or become life-threatening. Since patients' bodies are essentially sending data to their healthcare teams for plans and treatments, this proactive healthcare paradigm is intrinsically individualized.

### Genome Sequencing

Understanding key disorders are now possible because of whole genome sequencing, which is now possible for researchers and medical scientists. Understanding how DNA and genes might cause illnesses is made possible by genome sequencing. For instance, whole genome sequencing has provided researchers with fresh knowledge on the heredity of schizophrenia.

### Drug Development

Since the existing approach is time-consuming and expensive, medical experts are looking for better and quicker ways to manufacture medications. To achieve this, they are utilizing in silico experiments and the capabilities of artificial intelligence.

### Nanotechnology

Nanotechnology can aid in the treatment and healing of wounds. For example, businesses are developing nanotechnology in the form of patches to monitor wounds and perhaps speed up recovery.

### 3D Printing

An item can be built from nothing via 3D printing. Making prosthetic limbs, blood arteries, and even biological tissues is possible in the medical field using 3D printers. Pharmaceutical firms have even 3D-printed medications in some instances. Experts anticipate that 3D printing in healthcare will see more applications as time goes on.

### Robotics

Robots may be terrific companions for those who are unwell and have been used to assist patients recovering after surgery. Startups are even developing methods for using robots to check medicine for sick children.

The abovementioned must be accounted for in the architecture and layout of hospitals. To stay up with this dynamic and demanding industry, Mada Gypsum Company always works to expand its product line and offer new solutions.

## General Design Considerations

# 3

The most complex building kinds are hospitals since they provide a wide range of services and are composed of several functional divisions. Hospitals offer inpatient care or bed-related tasks in addition to hospitality tasks like meal service and housekeeping. Additionally, they provide diagnostic and therapeutic duties in areas including surgery, radiology, emergency rooms, and clinical laboratories.

A good hospital design integrates the practical requirements with the human needs of its numerous patients. This requirement for a diversity of tasks is reflected in the breadth and complexity of regulations, guidelines, and oversight that guide hospital creation and operations. It takes specialized knowledge and skill to perform each of the numerous, varied, and dynamic jobs required by hospitals, including those involving their complex mechanical, electrical, and telecommunications systems.

The constraints and opportunities of the location, the climate, the nearby amenities, the budget, and the technology available all have an impact on hospital design. Regardless of location, size, and services, hospitals share the following characteristics:

### Efficiency and Cost-Effectiveness

An effective hospital layout should encourage staff efficiency by reducing the distance that staff must travel between frequently used spaces; allowing for visual patient supervision; making efficient use of multipurpose spaces; and, whenever possible, consolidating spaces.

### Flexibility and Expandability

Hospitals should be open-ended with well-planned directions for future extension, employ generic room sizes and layouts to the greatest extent feasible, and use modular, conveniently accessible, and easily modifiable mechanical and electrical systems.



- Efficiency and Cost-Effectiveness



- Flexibility and Expandability



- Therapeutic Environment



- Cleanliness and Sanitation



- Accessibility



- Security and Safety



- Sustainability



## General Design Considerations *(continued)*

### Therapeutic Environment

A hospital should be perceived as welcoming, relaxing, and unthreatening by patients and visitors. The attempt to create a therapeutic atmosphere includes a significant contribution from the interior designer.

### Cleanliness and Sanitation

Hospitals must be simple to maintain and clean. To eliminate dirt-attracting and difficult-to-clean cracks and joints, meticulous detailing of elements like doorframes, casework, and finish transitions is used, as well as enough strategically placed housekeeping spaces.

### Accessibility

The Disabilities Act should be followed in all locations, both inside and out. This includes making sure that gradients are level enough to allow for simple movement and that walkways and hallways are large enough to accommodate two wheelchairs.

### Security and Safety

Security and safety must be incorporated into the design of hospitals to assure the safety of patients, personnel, hospital property, and assets (including pharmaceuticals), as well as a hospital's vulnerability.

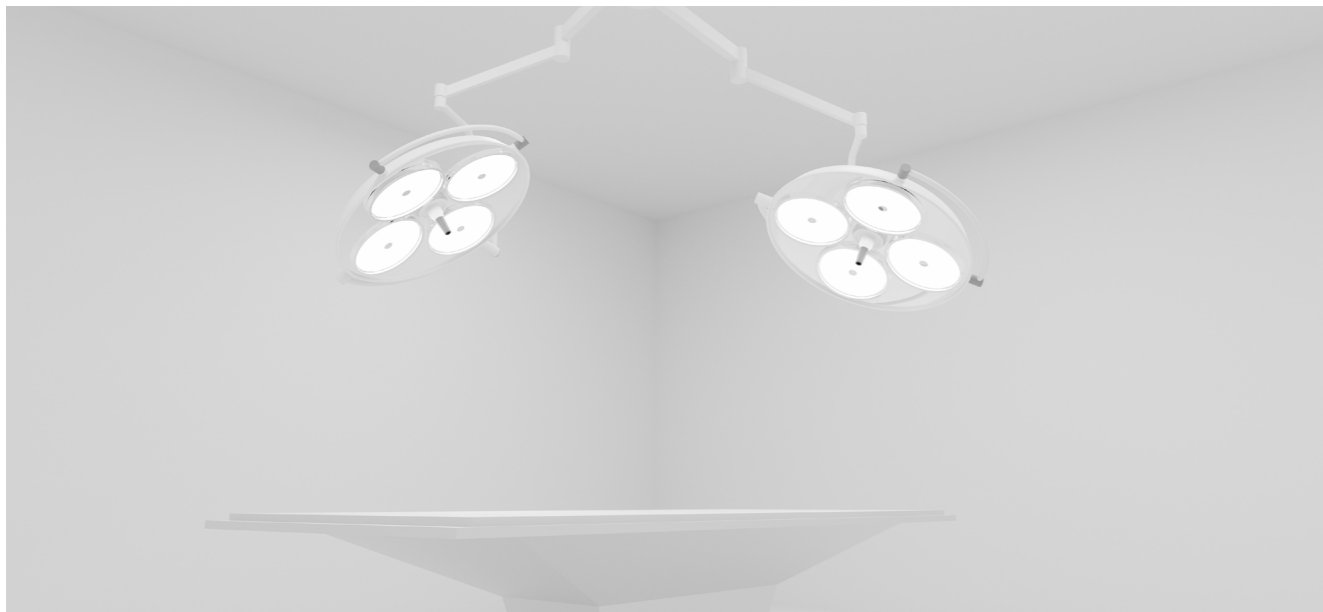

### Sustainability

Hospitals have a big influence on the neighborhood's economy and ecology. They generate a lot of garbage and require a lot of energy and water. Because of this, hospitals must be designed and built with sustainability in mind.

### Mada Gypsum Company (Mada)

With more than 25 years of experience in providing solutions for the healthcare sector, Mada understands that a successful hospital design and building project requires careful planning with the right solutions. Mada's team approach to architecture and construction, working together with the designers, specifiers, developers, contractors, and consultants eliminate many problems in the design and construction, resulting in a smooth experience.

## 3.1 Fire Safety

When considering if a material is safe to be used inside a modern building, it is important to consider its reaction to a fire.

Materials inside a building can significantly affect the spread of fire and its growth rate, even though they are most likely not the source of the original ignition. Therefore, the correct selection of materials is an essential part of fire safety, and the choice of linings and coverings is critical in:

- Circulation spaces where adjoining surfaces provide the primary means for fire to spread.
- Areas (hallways, lobbies, and stairs) where rapid spread is most likely to prevent occupants from exiting the building.

Designers and architects should focus attention on two critical properties of lining materials that influence fire spread:

- The rate flame spreads over the surface when subjected to an intense radiant heating source.
- The rate at which the tested material gives off heat when burning.

### 3.1.1 - Compartmentation

Compartmentation strategies (separating sub-assemblies using fire-resistive construction techniques) can effectively reduce or restrict the building's risk of fire spread.

Two key objectives of compartmentation are:

- To prevent rapid fire and smoke spread, potentially trapping occupants in the building.
- To reduce the chance of fires growing in size and temperature, which could affect occupants, fire service personnel, and people in the vicinity of the building.

- Determining the level of compartmentation needed depends on three key factors:

- The building's use and fire load, which affects the potential for and the severity of a fire and building evacuation strategies.
- The height to the top story of the building indicates the ease of evacuation and the accessibility for firefighters and first responders.
- The building code standards of the Authority Having Jurisdiction (AHJ) over the project permits and inspections.

Time Temperature Curve for Fire-Endurance Testing

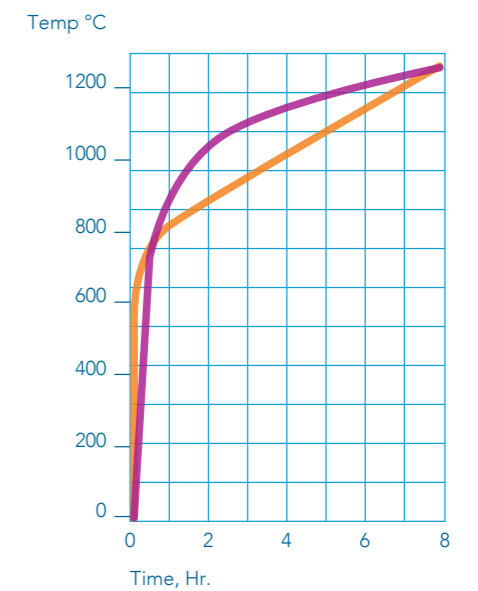

— BS 476: Part 20: 1987  
— ASTM E119

## 3.2 Acoustics

### 3.2.1 - Acoustics and Sound Insulation

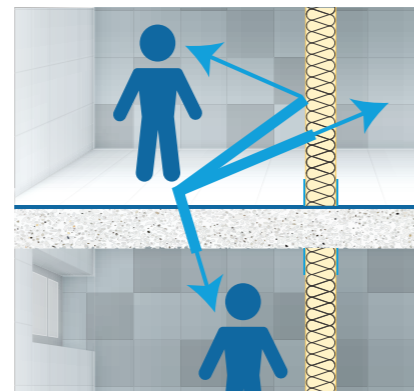
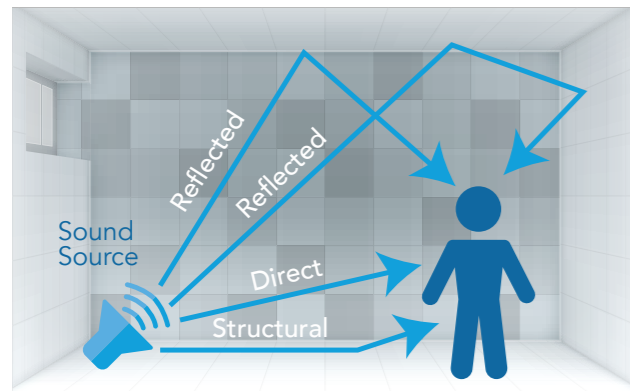

Figure 1: Impact sound can affect those within spaces as airborne sound, and those in other parts of the building as structure born sound

The control of noise levels and the sound characteristics within a space and noise transmission from one area to another is known as Building Acoustics. Noise can be an undesirable sound, but this is subjective and depends on the individual. Unpleasant sounds can reduce the occupant’s comfort and efficiency, and long-term exposure can cause physical discomfort and mental distress.

Sound insulation refers to the process of reducing sounds that moves from one defined space to another, separated by a dividing element. Direct transmission occurs when sound travels through the dividing element. Indirect transmission (flanking) refers to sound traveling through the adjoining building structure. An effective sound insulation solution will address both types of sound transmission.

Sound insulation requirements must consider both internal and external sound transmission sources to be completely effective. Building Acoustics includes two distinct components, sound insulation, and sound absorption.

### 3.2.2 - Guide to sound insulation levels for speech privacy

STC	Speech privacy
25 dB	Normal speech can be heard quite easily and distinctly
30 dB	Loud speech can be understood fairly well; Normal speech can be heard but not understood
35 dB	Loud speech can be heard but not intelligible
42 dB	Loud speech is audible as a murmur
45 dB	Loud speech is not audible
50 dB	Very loud sounds such as musical instruments or a stereo can be faintly heard
65 dB	Very loud speech cannot be heard
75 dB	Extremely loud speech cannot be heard

Sound absorption occurs when sound waves contact an absorbent surface such as a wall, ceiling, or floor and don’t reflect any sound back into the space, is sound absorption. Products and materials fall into classes ranging from A (the best) through E, based on their sound absorption abilities when tested.

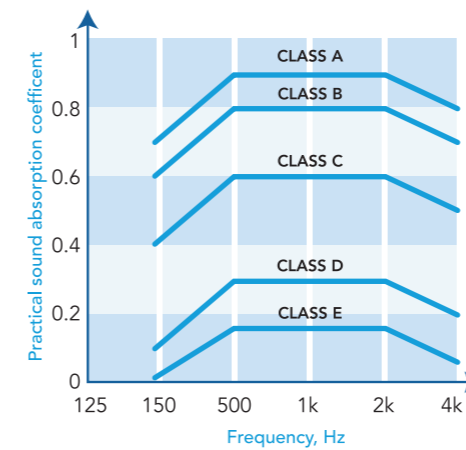

Illustration of the reference curve limiting the different sound absorption classes, from BS EN ISO 11654: 1997.

Sound and noise levels get expressed in either: Decibels (dB) - a logarithmic unit used to measure sound level, or Hertz (Hz) – measures the frequency of the wave.

As the ear detects changes in sound pressure, they become electrical impulses and get sent to the brain. The brain converts the impulses to auditory signals, allowing us to hear sound and noise between the 20 Hz and 20,000 Hz range.

Humans interpret a 10 dB increase as doubling the sound level, which explains why a pneumatic drill (100 dBA) seems four times louder than a person shouting (80dBA). And why a 10 dBA reduction in the sound level makes an area seem 50% quieter.

In humans, the optimum hearing occurs in the speech range, or middle-frequency sounds ranging from 500 Hz to 4,000 Hz. Hearing ability can vary from one individual to the next, depending on age, physical health, or previous long-term exposure to excessive noise.

Sound level dBA (log scale)	Sound Source
0	Threshold and audibility
20	Whisper
30	Quiet conversation
40	Background noise in unoccupied office
50	Normal conversation
60	Occupied offices
70	Inside a travelling railway carriage
80	Road side, busy street
100	Inside a nightclub
120	Jet aircraft taking off 100m away or MP3 player at maximum volume
120-130	Threshold of pain
140>	Damage to hearing

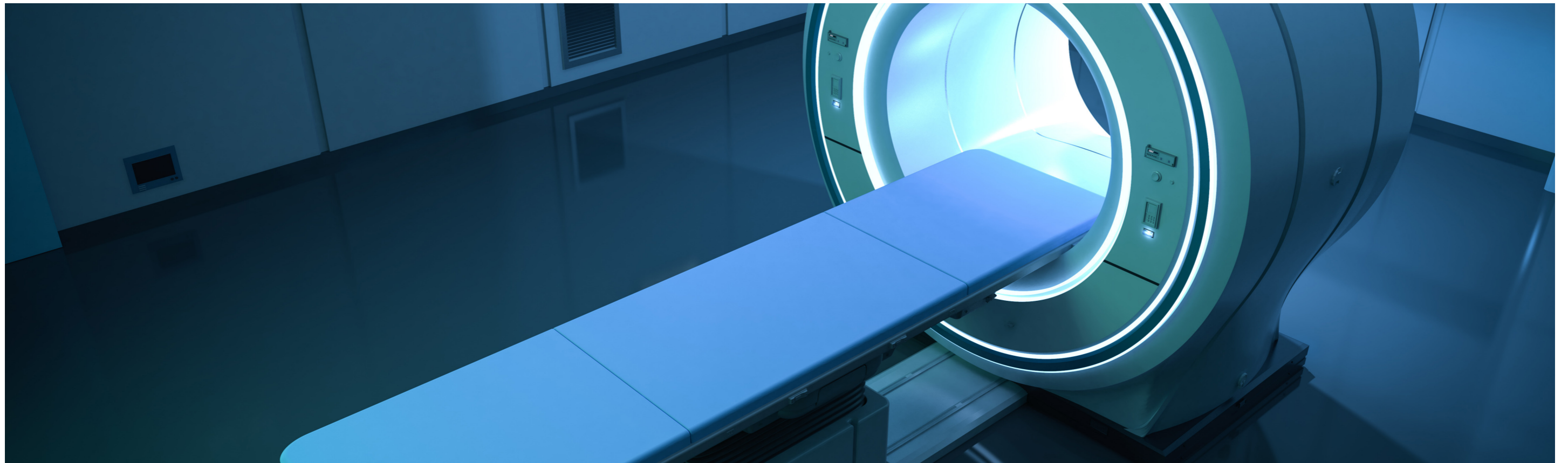

### 3.2.3 - Noise Leakage

The diminished acoustic performance will result if there are any cracks or gaps from one building service/component/assembly to another, as sound can quickly move through the air from one area to another. Here are a few of the most common noise leakage culprits.

- Wall and floor openings where distribution services such as wiring, pipes, or ducts pass from one area to another.
- Continuous curtain walling or internal lining system installations.
- Perimeter junctions and joints where partitions, raised floors, and ceilings meet one another.
- Door vents and keyholes, the edges of improperly fitted doors, and thresholds without an acoustic seal.
- Air handling luminaires (grills and registers) in the suspended ceiling connecting to a common air supply/return plenum supplying adjacent areas.
- Recessed lighting fixture troughs that span across the top of a shared partition.
- Air ducts installed above the ceiling or below a raised floor supply air services to two or more areas.

### 3.2.4 - Indirect Sound Paths (Flanking Transmission)

Small gaps, cracks, holes, or other openings allow air-bound sound to travel to adjacent areas, reducing overall acoustic performance. Therefore, maximum sound transmission control requires an airtight seal around all penetrations. Use Mada Acoustical Sealant for small gaps and cracks, and for gaps greater than 5mm, where wallboards meet either the ceiling or floor surfaces, use Mada Jointing Compound.

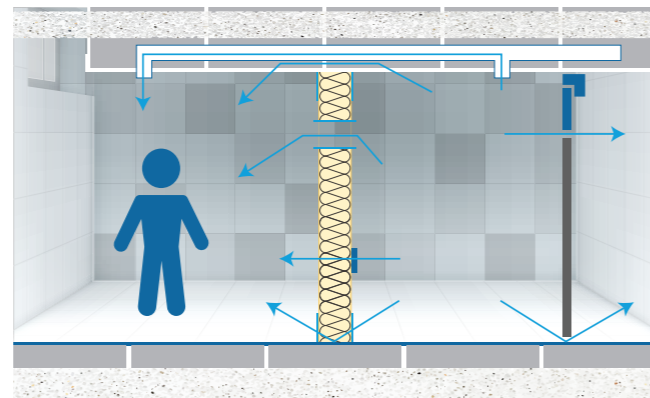
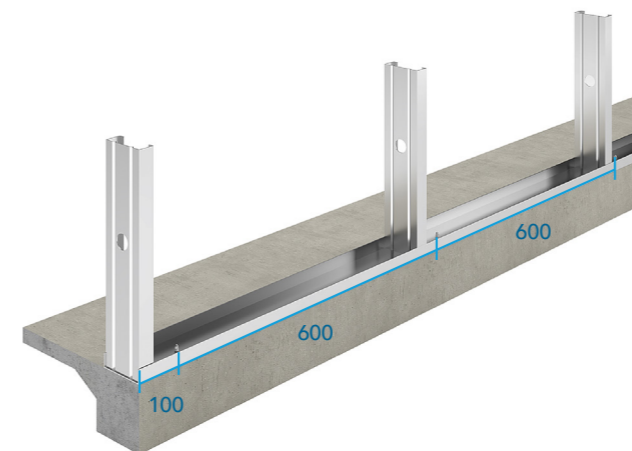

Figure 2: Typical flanking paths around partitions

## 3.3

### Structure

Mada wall and ceiling framing systems are designed and manufactured to meet the most demanding job site requirements and applicable building codes. A safe and effective framing system must meet/exceed the structural requirements for wind, live & dead loads, and other project-specific types of potential loading.



Safe and effective wall design should allow for the following factors and considerations:

- Loadings created by potential external/internal pressure differences
- Vertical loads
- Adequate support for wall-mounted accessories and materials such as shelves, cabinets, and siding
- Vertical deflection resulting from movement of the building
- Proper support of windows/door openings (including lateral support)
- Thermal expansion from fire or excessive heat

Mada steel frame design solutions consider the following basis:

- Allowable Strength Design (ASD)
- Load and Resistance Factor Design (LRFD)
- Load Combinations

Typical additional considerations include:

- Local Buckling, Distortional Buckling, and Post-buckling Strength of Thin Compression Elements
- Torsional Rigidity
- Variable Properties of Sections Having Stiffened or Unstiffened Compression Elements
- Connections
- Web Crippling Strength

### 3.3.1 - Maximum Wall Heights

Non-load bearing steel stud framing systems must not exceed the heights given in the Framing Systems Section.

Maximum heights consider the maximum allowable deflection at mid-point.

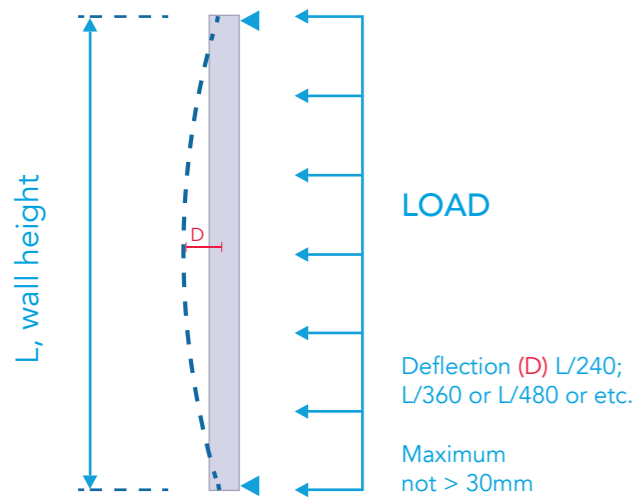

The maximum height for non-loadbearing walls has been provided for:

**SBC compliance** - 0.25KPa lateral pressure and based on L/240 (deflection criteria) per the NCC.

**International Industry Standard** – 0.2KPa lateral pressure and based on L/240 (deflection criteria) per the NCC.

Additionally, finishes or loads may indicate the acceptable level of mid-point deflection. For example:

- L/240
  - General partition
  - Paint / wallpaper finish
- L/360
  - Brittle finish (stone tiles or mosaic)
  - Higher level of finish required
- L/480
  - Eccentric (shelf loads)

For all other design pressure or limiting deflection criteria questions, please contact the Mada Technical Team.

### 3.3.2 - Head Clearance / Deflection Heads

Virtually every structure will experience deflection during its lifetime. Designers must consider potential live, dead, and other loadings on non-loadbearing walls since they are not designed to take on axial loading deflection.

The included standard head details should accommodate most service deflection requirements. Please contact the Mada Technical Team for further deflection head design assistance.

### 3.3.3 - Movement

Where linings and other wall and ceiling assemblies cross a structural movement joint, they will require a matching movement joint. Contact the Mada Technical Team for assistance with expansion joint options to meet your specific needs.

*For more information, please consult the Mada System guide.*

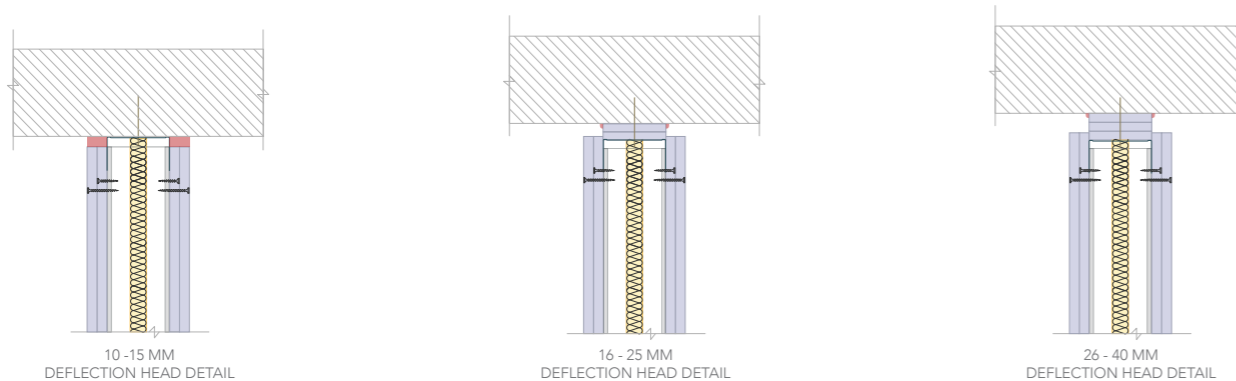

## 3.4

### Maintenance Cost

Maintenance Cost consideration is a critical aspect of healthcare building design for the various needs in the healthcare industry, Mada Gypsum Company created several single- and multi-layer systems. When compared to conventional masonry systems, these systems provide considerable advantages that boost

maintenance effectiveness as well as cost-effective alternatives to fulfill capital and revenue requirements:

- Greater flexibility for high-frequency remodeling
- Integration of mechanical and electrical services
- Installation cost savings
- Cost-effective and more environmentally friendly disposal
- Build program predictability
- Reduced disruption costs



## 3.5

### Service Integration

The following information is intended to support project detailing. Please note:

- All loadings are offered as Safe Working Loads (SWL) calculated using a safety factor of 4 (for steel fixings) or 7 (for plastic fixings) against the Typical Failure Load (TFL).
- Maximum heights of frames are explained in the Structure section
- Maximum height calculations do not include loadings
- For full calculations combining heights and loadings, please contact the Mada Technical team.
- Acoustic and fire performances can be affected by details

#### 3.5.1 - Fixtures Direct to Board

Component Recommended	Fixing Method	Load Capacity
	Wall Mate screw suitable for use with MADA gypsum board	5 kg
	Fisher Butterfly fixing into single layer MADA gypsum board	20 kg Shear Load

**3.5.2 - Fixing to Internal Framework**

Based on safety factor of 4 (steel fixings) and 7 (plastic fixings) has been used

Description (per fixing)	SWL	TFL
Mada drywall plasterboard screws through Mada 0.7mm thick metal framing (stud/ fixing channel)	19 Kg	76 Kg
Mada drywall plasterboard screws through Mada 0.9mm thick metal framing (stud/ fixing channel)	30 Kg	120 Kg
Mada self tapping screws fixed through Mada 0.9mm metal framing	50 Kg	200 Kg
Steel expanding metal cavity fixing m6 x 40 through Mada plasterboard into 0.9mm thick Mada metal frame	40 Kg	160 Kg
Steel expanding metal cavity fixing m6 x 65 through Mada plasterboard into 0.9mm thick Mada metal frame (board thickness 12.5mm to 25)	50 Kg	200 Kg

\*SWL: Safe working load

\*\*TFL: Typical failure load

**3.5.3 - Typical system detail**

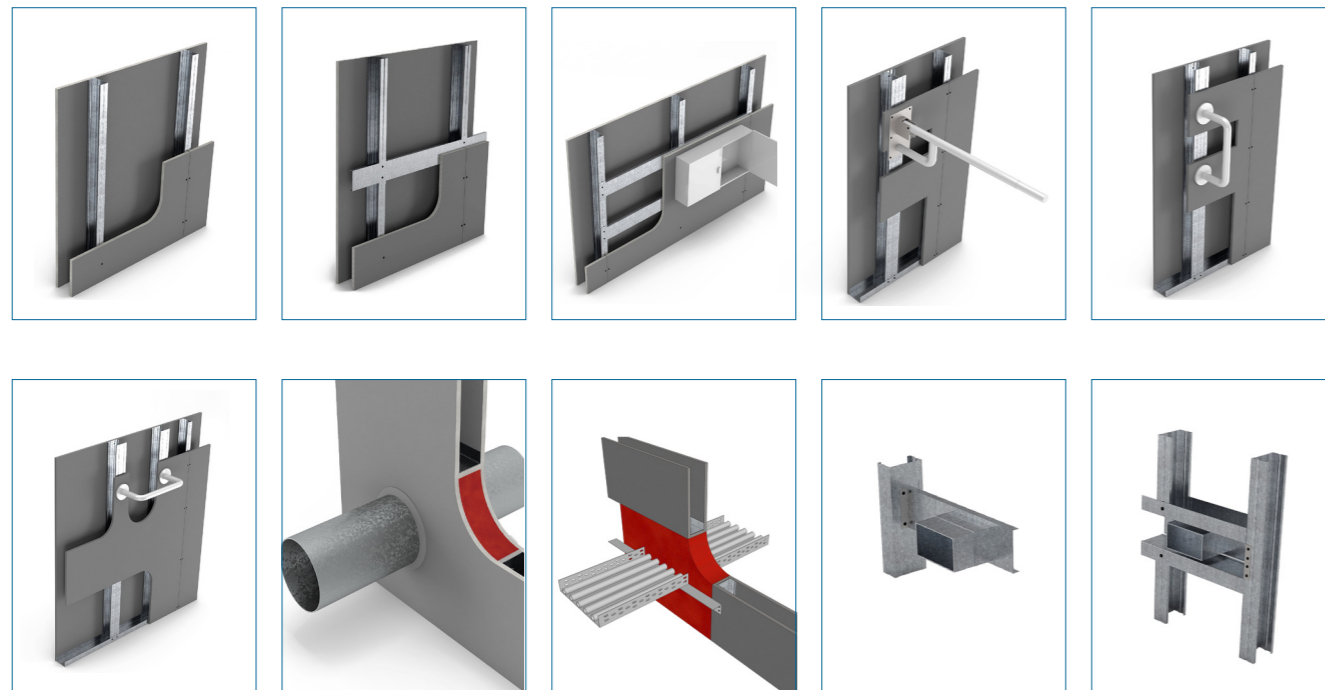

See project specification for exact requirements

Sector  
**Focus**

**4**

**4.1**

**Robustness**

The Building Regulations do not specifically detail requirements for the strength and robustness of partitions. However, BS 5234: Part 2: 1992 sets out structural performance requirements by room as per the below table:

BS5234: Part 2: 1992 Partition		
Duty	Category	Examples
Light	Adjacent space only accessible to persons with high incentive to exercise care. Small chance of accident occurring or of misuse	Domestic Accommodation
Medium	Adjacent space moderately used, primarily by persons with some incentive to exercise care. Some chance of accident occurring or of misuse	Office Areas
Heavy	Adjacent space frequently used by the public and others with little incentive to exercise care. Chances of accident occurring or of misuse	Public circulation areas
Severe	Adjacent space intensively used by the public and others with little incentive to exercise care. Prone to vandalism and abnormal rough use	Major circulation areas

Source: BS 5234: Part 2: 1992





## 4.2 Visual Aesthetics

In contrast to the European standard, which is excellent for understanding the level of robustness a partition can endure without failing, and consequently, which full constructions are fit-for-purpose, the ASTM C1629 Standard Classification for Abuse-Resistant Nondecorated Interior Gypsum Panel Products and Fiber-Reinforced Cement Panels assesses products and includes testing on the levels of Surface Abrasion Resistance and Indentation Resistance.

These subtle differences generate a focus on two linked elements of robustness:

- The ability of a construction to withstand differing types and levels of impact
- The appearance of a surface after testing. This means that only by considering both elements will a designer maximize maintenance cycles, minimize disruption, and ensure the visual appeal of the building is retained.

MGC has developed the Mada Plus Impact Resistant board specifically to comply with ASTM C1629. When a 16mm Mada Plus Impact Resistant board is constructed on either side of a Mada framework it will also achieve a Severe Duty rating of BS 5234.

## 4.3 Speech Clarity

Speech clarity refers to how well the listeners can understand the speaker. It might be challenging to hear speech in a reverberant space with distracting background noise.

The term "direct sound" refers to the sound that reaches the listener first. Then come the first reflections. Speech clarity benefits from the early reflections' integration with the direct sound, which reaches the listener within 50 ms. The reflections that follow might be considered disturbing.

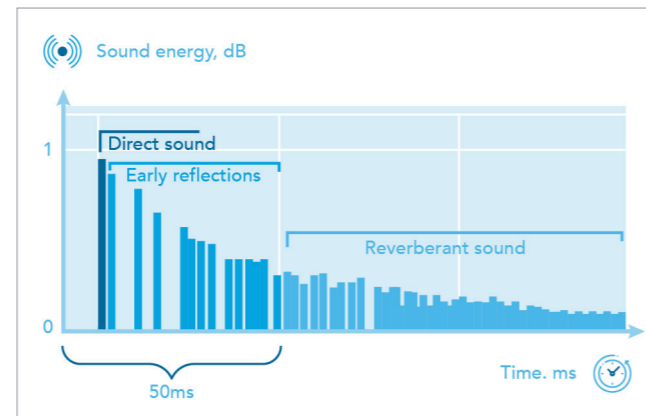
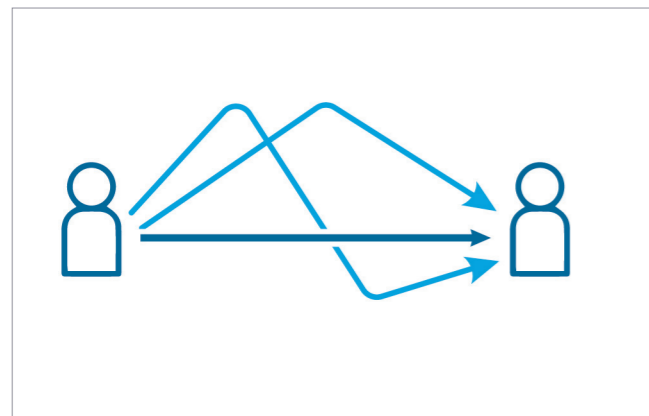

## AMBIENT OR BACKGROUND NOISE LEVEL

Is the totality of all sounds within the room when the room is unoccupied

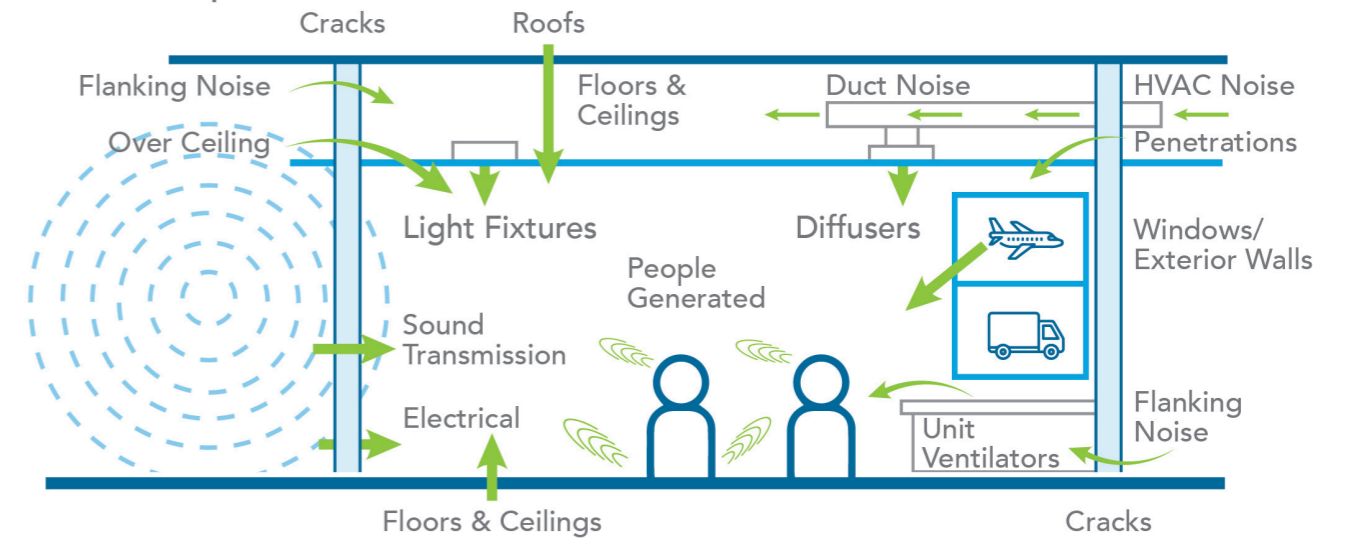

### Background Noise Sources:

- Through walls from adjacent rooms.
- Over the ceiling from adjacent rooms.
- Through doors, around the frame and under the door.
- Through ventilators or louvers above door units.
- Through HVAC ductwork from adjacent rooms.
- HVAC noise from ceiling diffusers.
- Through the light fixtures.

- From outside, through exterior walls and windows.
- From the floor above.

To obtain a good signal-to-noise ratio in the room, it is crucial to identify and evaluate noise levels. The examination of space to see if it is appropriate for the use of Sound Field Amplification equipment is also crucial.

### 4.3.1 - Reverberation and Reverberation Time

Reverberation is primarily dependent on only two things:

- The volume of the space
- The amount of absorption in the space.

Even though some room reverberation can help with voice dispersion, prolonged reverberation periods can lead to a buildup of noise and deteriorate speech clarity.

where T is the reverberation time in seconds, 0.049 is a constant, V is the volume of the space, S is the surface area of all the surfaces and a is the absorption coefficient of the building material at a given frequency.

It is the designer or architect's responsibility to ensure that space meets the required reverberation times by providing the appropriate number of absorptive materials.

The Sabine Formula for calculating the RT in a space is a simple mathematical formula presented as:

*Mada recommends assigning a specialized acoustician for spaces where the acoustics requirements are stringent.*

$$T = 0.049 \frac{V}{S}$$

### 4.3.2 - Sound Transmission Class

The amount of airborne sound blocked from transmitting through a partition is measured in a Sound Transmission Class (STC) rating. A higher STC rating will Sound transmission through walls will add to the background noise level in the space, degrading the ability to hear and understand speech.

Single or composite walls, floor-ceiling, and roof-ceiling assemblies should provide specific sound transmission class (STC) ratings when adjacent spaces:

Operatable STC Rating	Speech Levels
STC-30	Loud speech understood
STC-35	Loud speech heard
STC-40	Loud speech quietly audible
STC-45	Some loud speech barely audible
STC-48	Hearing strained to hear loud speech
STC-50	Loud speech not audible

The materials and installation techniques utilized have a significant impact on the STC rating. To achieve a desired STC rating, wall and ceiling assemblies can be defined and detailed. The architect or designer is in charge of this. However, more will be needed than just stating an STC level. It is significant to note that sound leakage through penetrations, joints, and over or around the structure can have a significant impact on sound transmission.

The design should consider the quantity and placement of wall penetrations as well as the quantity and location of electrical outlets. Installation techniques become essential for meeting a defined STC. To reduce sound transfer between rooms, the electrical system placement and installation instructions are provided in Annex B. Electrical boxes shouldn't be placed in the same stud space as studs on single-stud walls. Boxes should be at least 24" apart for walls with staggered or dual studs. If it is impossible to avoid them, back-to-back electrical boxes should be encased in complete gypsum board enclosures that do not touch the framing of the adjacent row of studs. Additionally, caulking or acoustical sealant should be used to completely seal off any connections and air gaps.

As was previously said, background noise is a major issue in learning environments. STC ratings will aid in reducing background noise levels in a location (depending on the effect of sound transmission on the background noise level). To satisfy a particular background noise level requirement, it can be necessary to raise a needed STC rating.

Good site selection and space planning can prevent or decrease sound transmission issues.

### 4.3.3 - Impact Insulation Class

A floor-ceiling assembly's capacity to prevent impact/structure-borne noise from transferring to the area below is measured by its Impact Insulation Class (IIC). A floor-ceiling assembly with a low IIC rating may generate distracting noise in the space below, which might result in aggravation and communication issues.

The floor-ceiling system needs to be designed and built to achieve the required IIC rating. Rubber pads or spring systems need to be provided for any vibrating equipment that is mounted on the structure of the roof or above the floor. As with all other criteria in the standard, it is up to the architect or designers to specify and build accordingly, although careful construction and installation will be needed to guarantee compliance.

## Solution Selection

# 5

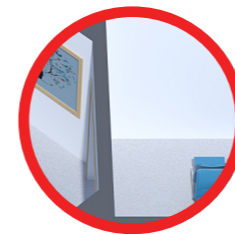
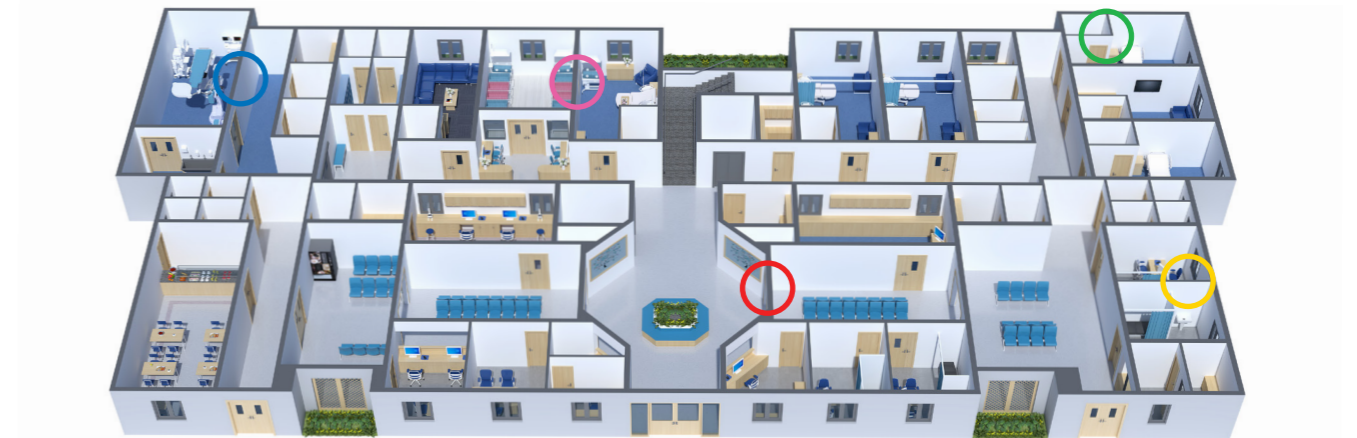

40 dB Range  
Waiting Room to Corridor



45 dB Range  
Single Bed to Toilet

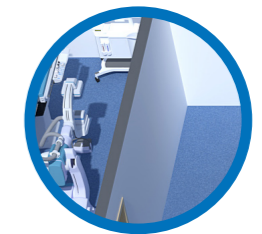

50 dB Range  
Operation to Room Corridor



55 dB Range  
Consulting room to Consulting room

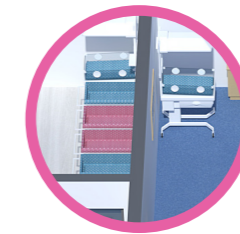

60 dB Range  
Nursery to Multibed Room

## 5.1 Partitions

Unwanted noise from surrounding places might interfere with treatments and recuperation. Health Technical Memorandum 08 - 01 (HTM 08-01) sets performance parameters for the attenuation of airborne sound transmission between adjacent rooms in terms of the weighted level difference  $D_{nT,w}$ . These parameters are determined by the source room's need for privacy, how much noise it produces, and how much noise it can tolerate.  $D_{nT,w}$  is used to express the minimal weighted sound level difference across rooms. The partitioning performances, however, are based on laboratory airborne sound insulation data expressed in terms of the sound reduction index  $R_w$ . The process that follows may be used to choose the best partition specification by applying a correction factor to account for this discrepancy.

#1: Determine the minimum weighted standardized sound level difference between rooms in each direction from the matrix in section 5.1.1

#2: Calculate the minimum required sound reduction index  $R_w$  using the following formula:

$$R_w = D_{nT,w} + 10 \log (S/V) + 12 \text{ dB}$$

Where: S = surface area of the separating element  
V = volume of the receiving room

HTM 08-01 states for lightweight partitions that the  $R_w$  value should be a minimum of 5 dB higher than  $D_{nT,w}$  even for very well-controlled flanking. To account for less favorable mounting conditions and flanking noise transmission, HTM 08-01 recommends the difference between  $R_w$  and  $D_{nT,w}$  is at least 7 dB. Higher values may be required depending on the quality of the flanking details – an acoustic consultant should be appointed to advise in this respect.

Therefore, the weighted sound reduction index  $R_w$  that HTM 08-01 recommends is used to select the partition from laboratory test data where there are unfavorable flanking conditions is:

$$R_w = D_{nT,w} + 10 \log (S/V) + 14 \text{ dB}$$

Where: S = surface area of the separating element  
V = volume of the receiving room

If the receiving room does not have the minimum absorption area that is equivalent to a Class C absorber (as defined in BS EN ISO 11654: 1997) covering 80% of the ceiling area, then a 3 dB correction should be added to the required weighted sound reduction index of the partition. If the receiving room satisfies the absorption criteria no correction factor is applied to the  $R_w$  value. For areas using Class A or B absorbers, less surface area will be required.

Therefore, the weighted sound reduction index  $R_w$  that HTM 08-01 recommend is used to select the partition from laboratory test data is:

$$\text{Minimum: } R_w = D_{nT,w} + 3\text{dB} + 10 \log (S/V) + 12 \text{ dB}$$

$$\text{Recommended: } R_w = D_{nT,w} + 3\text{dB} + 10 \log (S/V) + 14 \text{ dB}$$

Where: S = surface area of the separating element  
V = volume of the receiving room  
3dB = absorption correction factor

To note it is not possible to calculate the acoustic requirements by room type without precise room dimensions.

As a summary:

	Class C Ceiling	No Class C Ceiling
Minimum dB	$R_w = D_{nT,w} + 10 \log (S/V)+12$	$R_w = D_{nT,w} + 10 \log (S/V)+15$
Recommended dB	$R_w = D_{nT,w} + 10 \log (S/V)+14$	$R_w = D_{nT,w} + 10 \log (S/V)+17$





5.1.2 - Partition System References by Range

40 dB Range



**Detail MON 1**  
No insulation

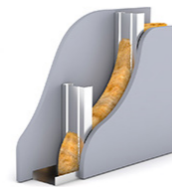

**Detail MON 2**  
25 mm of Mada Glasswool insulation (16kg/m<sup>3</sup>)

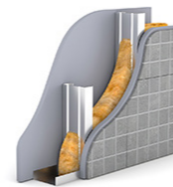

**Detail AQU 2**  
25mm of Mada Glasswool insulation 16Kg/m<sup>3</sup>

System Ref.	Width (mm)	Stud (mm)	Section Detail	Board Configuration per Side	STC	Max. H (mm) / 0.24kPa	R <sub>w</sub> (dB)	Max. H (mm) / 0.20kPa
<b>30 Min Fire Rating</b>								
MON112*	75	48x0.55	MON 2	1 x 12.5 Fire Resistant	37	2800	40	3050
MON103*	75	48x0.55	MON 1	1 x 12.5 Impact Resistant	37	2800	40	3050
MON205*	102	68x0.55	MON 1	1 x 16 Regular	40	3850	40	4200
MON203*	95	68x0.55	MON 1	1 x 12.5 Impact Resistant	41	3700	41	4050
MON305*	132	98x0.55	MON 1	1 x 16 Regular	41	4900	41	5350
MON111*	75	48x0.55	MON 2	1 x 12.5 Regular	40	2800	42	3050
MON211*	95	68x0.55	MON 2	1 x 12.5 Regular	40	3700	42	4050
MON311*	125	98x0.55	MON 2	1 x 12.5 Regular	40	4600	42	5050
MON411*	175	148x0.80	MON 2	1 x 12.5 Regular	40	6800	42	7300
MON402*	175	148x0.80	MON 1	1 x 12.5 Fire Resistant	41	6800	42	7300
MON303*	125	98x0.55	MON 1	1 x 12.5 Impact Resistant	45	4600	43	5050
MON405*	182	148x0.80	MON 1	1 x 16 Regular	41	6950	43	7450
MON312*	125	98x0.55	MON 2	1 x 12.5 Fire Resistant	44	4600	44	5050
AQU1144	75	48x0.55	AQU 2	1 x 12.5 ProGuard	39	2800	41	3050
<b>60 Min Fire Rating</b>								
MON106	82	48x0.55	MON 1	1 x 16 Fire Resistant	42	2950	41	3200
MON206	102	68x0.55	MON 1	1 x 16 Fire Resistant	41	3850	41	4200
MON306	132	98x0.55	MON 1	1 x 16 Fire Resistant	41	4900	41	5350
MON406	182	148x0.80	MON 1	1 x 16 Fire Resistant	41	6950	41	7450
MON207	102	68x0.55	MON 1	1 x 16 Impact Resistant	45	3850	43	4200
AQU1188	82	48x0.55	AQU 2	1 x 16 ProGuard	40	2950	41	3200

Range minimized to aid selection. For other stud specifications and height requirements, please consult the system guide and contact Mada Technical Team.

\* System not suitable for severe duty

45 dB Range



**Detail MON 1**  
No insulation

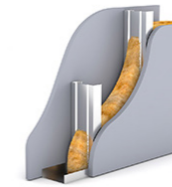

**Detail MON 2**  
25 mm of Mada Glasswool insulation (16kg/m<sup>3</sup>)



**Detail MUL 1**  
No Insulation

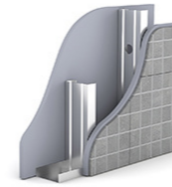

**Detail AQU 1**  
No insulation

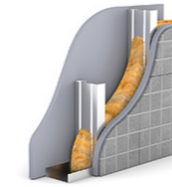

**Detail AQU 2**  
25mm of Mada Glasswool insulation 16Kg/m<sup>3</sup>

System Ref.	Width (mm)	Stud (mm)	Section Detail	Board Configuration per Side	STC	Max. H (mm) / 0.24kPa	R <sub>w</sub> (dB)	Max. H (mm) / 0.20kPa
<b>30 Min Fire Rating</b>								
MON213*	95	68x0.55	MON 2	1 x 12.5 Impact Resistant	46	3700	46	4050
MON403*	175	148x0.80	MON 1	1 x 12.5 Impact Resistant	46	6800	46	7300
MON315*	132	98x0.55	MON 2	1 x 16 Regular	48	4900	47	5350
MON412*	175	148x0.80	MON 2	1 x 12.5 Fire Resistant	48	6800	47	7300
MON313*	125	98x0.55	MON 2	1 x 12.5 Impact Resistant	50	4900	49	5350
MON415*	182	148x0.80	MON 2	1 x 16 Regular	48	6950	49	7450
AQU1099	75	48x0.55	AQU 1	1 x 12.5 Procem	46	2500	46	2750
AQU1192**	75	48x0.55	AQU 2	1 x 12.5 Procem	49	2500	48	2750
<b>60 Min Fire Rating</b>								
MON307	132	98x0.55	MON 1	1 x 16 Impact Resistant	46	4900	45	5350
MON407	182	148x0.80	MON 1	1 x 16 Impact Resistant	46	6950	47	7450
MON217	102	68x0.55	MON 2	1 x 16 Impact Resistant	50	3850	48	4200
MUL101	100	48x0.55	MUL 1	2 x 12.5 Regular	50	3100	49	3600
MUL201	120	68x0.55	MUL 1	2 x 12.5 Regular	50	4100	49	4800
MUL301	150	98x0.55	MUL 1	2 x 12.5 Regular	50	5100	49	6000
MUL401	200	148x0.80	MUL 1	2 x 12.5 Regular	50	7300	49	8300

Range minimized to aid selection. For other stud specifications and height requirements, please consult the system guide and contact Mada Technical Team.

\* System not suitable for severe duty

\*\* Asymmetrical solution - other side is 12.5 Fire Resistant

### 50 dB Range



**Detail MON 2**  
25 mm of Mada Glasswool insulation (16kg/m<sup>3</sup>)

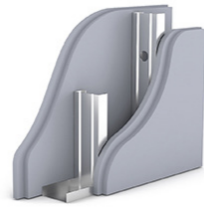

**Detail MUL 1**  
No Insulation

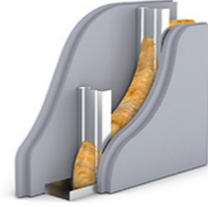

**Detail MUL 2**  
25mm of Mada Glasswool insulation 16Kg/m<sup>3</sup>

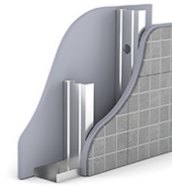

**Detail AQU 1**  
No insulation

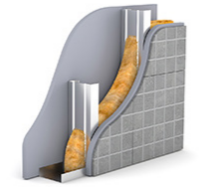

**Detail AQU 2**  
25mm of Mada Glasswool insulation 16Kg/m<sup>3</sup>

System Ref.	Width (mm)	Stud (mm)	Section Detail	Board Configuration per Side	STC	Max. H (mm) / 0.24kPa	R <sub>w</sub> (dB)	Max. H (mm) / 0.20kPa
<b>30 Min Fire Rating</b>								
MON413*	175	148x0.80	MON 2	1 x 12.5 Impact Resistant	51	6800	51	7300
<b>60 Min Fire Rating</b>								
MON317	132	98x0.55	MON 2	1 x 16 Impact Resistant	51	4900	50	5350
MON417	182	148x0.80	MON 2	1 x 16 Impact Resistant	51	6950	52	7450
MUL405	214	148x0.80	MUL 1	2 x 16 Regular	53	7350	52	8350
MUL111	100	48x0.55	MUL 2	2 x 12.5 Regular	54	3100	54	3600
MUL211	120	68x0.55	MUL 2	2 x 12.5 Regular	54	4100	54	4800
MUL311	150	98x0.55	MUL 2	2 x 12.5 Regular	54	5100	54	6000
MUL411	200	148x0.80	MUL 2	2 x 12.5 Regular	54	7300	54	8300
AQU11PP	80	48x0.55	AQU 2	1 x 15 Procem	52	2650	51	2900
<b>120 Min Fire Rating</b>								
MUL102	100	48x0.55	MUL 1	2 x 12.5 Fire Resistant	52	3100	51	3600
MUL202	120	68x0.55	MUL 1	2 x 12.5 Fire Resistant	52	4100	51	4800
MUL302	150	98x0.55	MUL 1	2 x 12.5 Fire Resistant	52	5100	51	6000
MUL402	200	148x0.80	MUL 1	2 x 12.5 Fire Resistant	52	7300	51	8300
MUL105	114	48x0.55	MUL 1	2 x 16 Regular	53	3150	52	3650
MUL205	136	68x0.55	MUL 1	2 x 16 Regular	53	4150	52	4850
MUL305	166	98x0.55	MUL 1	2 x 16 Regular	53	5300	52	6200
AQU104444	100	48x0.55	AQU 1	2 x 12.5 ProGuard	50	3100	51	3600

Range minimized to aid selection. For other stud specifications and height requirements, please consult the system guide and contact Mada Technical Team.

\* System not suitable for severe duty

### 55 dB Range



**Detail MUL 1**  
No Insulation

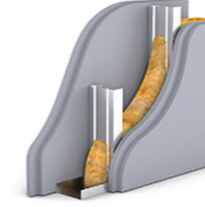

**Detail MUL 2**  
25mm of Mada Glasswool insulation 16Kg/m<sup>3</sup>



**Detail FIR 1**  
No Insulation

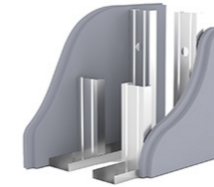

**Detail SOU 1**  
No insulation

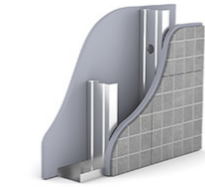

**Detail AQU 1**  
No insulation



**Detail AQU 2**  
25mm of Mada Glasswool insulation 16Kg/m<sup>3</sup>

System Ref.	Width (mm)	Stud (mm)	Section Detail	Board Configuration per Side	STC	Max. H (mm) / 0.24kPa	R <sub>w</sub> (dB)	Max. H (mm) / 0.20kPa
<b>60 Min Fire Rating</b>								
MUL415	214	148x0.80	MUL 2	2 x 16 Regular	57	7350	57	8350
FIR101	125	48x0.55	FIR 1	3 x 12.5 Regular	56	3150	55	3650
FIR201	147	68x0.55	FIR 1	3 x 12.5 Regular	56	4150	55	4850
FIR301	177	98x0.55	FIR 1	3 x 12.5 Regular	56	5300	55	6200
FIR401	225	148x0.80	FIR 1	3 x 12.5 Regular	56	7350	55	8350
SOU105	160	48x0.55	SOU 1	2 x 16 Regular	54	2200	55	2450
SOU205	204	68x0.55	SOU 1	2 x 16 Regular	54	2500	55	2850
SOU305	264	98x0.55	SOU 1	2 x 16 Regular	54	3700	55	4150
SOU405	360	148x0.80	SOU 1	2 x 16 Regular	54	6100	55	6600
AQU109999	100	48x0.55	AQU 1	2 x 12.5 Procem	58	2800	57	3300
<b>120 Min Fire Rating</b>								
MUL203	120	68x0.55	MUL 1	2 x 12.5 Impact Resistant	56	4100	55	4800
MUL303	150	98x0.55	MUL 1	2 x 12.5 Impact Resistant	56	5100	55	6000
MUL403	200	148x0.80	MUL 1	2 x 12.5 Impact Resistant	56	7300	55	8300
MUL112	100	48x0.55	MUL 2	2 x 12.5 Fire Resistant	56	3100	56	3600
MUL107	114	48x0.55	MUL 1	2 x 16 Impact Resistant	55	3150	56	3650
MUL212	120	68x0.55	MUL 2	2 x 12.5 Fire Resistant	56	4100	56	4800
MUL207	136	68x0.55	MUL 1	2 x 16 Impact Resistant	55	4150	56	4850
MUL312	150	98x0.55	MUL 2	2 x 12.5 Fire Resistant	56	5100	56	6000
MUL412	200	148x0.80	MUL 2	2 x 12.5 Fire Resistant	56	7300	56	8300
MUL115	114	48x0.55	MUL 2	2 x 16 Regular	57	3150	57	3650
MUL215	136	68x0.55	MUL 2	2 x 16 Regular	57	4150	57	4850
MUL315	166	98x0.55	MUL 2	2 x 16 Regular	57	5300	57	6200
MUL213	120	68x0.55	MUL 2	2 x 12.5 Impact Resistant	58	4100	59	4850
MUL313	150	98x0.55	MUL 2	2 x 12.5 Impact Resistant	58	5100	59	6000
MUL413	200	148x0.80	MUL 2	2 x 12.5 Impact Resistant	58	7300	59	8350
AQU114444	100	48x0.55	AQU 2	2 x 12.5 ProGuard	56	3100	56	3600
<b>180 Min Fire Rating</b>								
MUL415	125	48x0.55	FIR 1	3 x 12.5 Fire Resistant	58	3150	57	3650
FIR101	147	68x0.55	FIR 1	3 x 12.5 Fire Resistant	58	4150	57	4850
FIR201	177	98x0.55	FIR 1	3 x 12.5 Fire Resistant	58	5300	57	6200
FIR301	225	148x0.80	FIR 1	3 x 12.5 Fire Resistant	58	7350	57	8350

Range minimized to aid selection. For other stud specifications and height requirements, please consult the system guide and contact Mada Technical Team.

### 60 dB Range

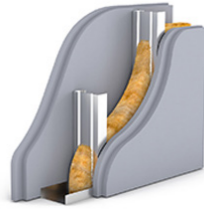

**Detail MUL 2**  
25mm of Mada Glasswool insulation 16Kg/m3

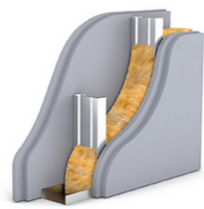

**Detail MUL 3**  
50mm of Mada Glasswool insulation 16Kg/m3



**Detail FIR 1**  
No Insulation

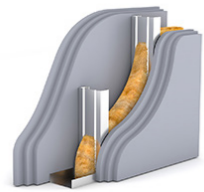

**Detail FIR 2**  
25mm of Mada Glasswool insulation 16Kg/m3



**Detail AQU 2**  
25mm of Mada Glasswool insulation 16Kg/m3

System Ref.	Width (mm)	Stud (mm)	Section Detail	Board Configuration per Side	STC	Max. H (mm) / 0.24kPa	R <sub>w</sub> (dB)	Max. H (mm) / 0.20kPa
<b>90 Min Fire Rating</b>								
FIR111	125	48x0.55	FIR 2	3 x 12.5 Regular	59	3150	60	3650
FIR211	147	68x0.55	FIR 2	3 x 12.5 Regular	59	4150	60	4850
FIR311	177	98x0.55	FIR 2	3 x 12.5 Regular	59	5300	60	6200
FIR411	225	148x0.80	FIR 2	3 x 12.5 Regular	59	7350	60	8350
AQU119999	100	48x0.55	AQU 2	2 x 12.5 Procem	61	2800	60	3300
AQU319999	150	98x0.55	AQU 2	2 x 12.5 Procem	61	4800	60	5700
<b>120 Min Fire Rating</b>								
MUL117	114	48x0.55	MUL 2	2 x 16 Impact Resistant	57	3150	60	3650
MUL217	136	68x0.55	MUL 2	2 x 16 Impact Resistant	57	4150	60	4850
MUL323	150	98x0.55	MUL 3	2 x 12.5 Impact Resistant	58	5100	60	6000
MUL317	166	98x0.55	MUL 2	2 x 16 Impact Resistant	57	5300	60	6200
FIR112	125	48x0.55	FIR 2	3 x 12.5 Fire Resistant	61	3150	61	3650
FIR103	125	48x0.55	FIR 1	3 x 12.5 Impact Resistant	61	3150	61	3650
FIR212	147	68x0.55	FIR 2	3 x 12.5 Fire Resistant	61	4150	61	4850
FIR203	147	68x0.55	FIR 1	3 x 12.5 Impact Resistant	61	4150	61	4850
FIR312	177	98x0.55	FIR 2	3 x 12.5 Fire Resistant	61	5300	61	6200
FIR303	177	98x0.55	FIR 1	3 x 12.5 Impact Resistant	61	5300	61	6200
FIR412	225	148x0.80	FIR 2	3 x 12.5 Fire Resistant	61	7350	61	8350
FIR403	225	148x0.80	FIR 1	3 x 12.5 Impact Resistant	61	7350	61	8350
<b>180 Min Fire Rating</b>								
FIR107	146	48x0.55	FIR 1	3 x 16 Impact Resistant	60	3150	61	3650
FIR207	168	68x0.55	FIR 1	3 x 16 Impact Resistant	60	4150	61	4850
FIR307	198	98x0.55	FIR 1	3 x 16 Impact Resistant	60	5300	61	6200
FIR407	246	148x0.80	FIR 1	3 x 16 Impact Resistant	60	7350	61	8350

Range minimized to aid selection. For other stud specifications and height requirements, please consult the system guide and contact Mada Technical Team.

### 65 dB Range

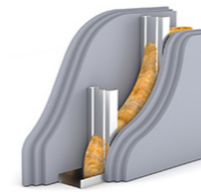

**Detail FIR 2**  
25mm of Mada Glasswool insulation 16Kg/m3



**Detail SOU 2**  
25mm of Mada Glasswool insulation 16Kg/m3

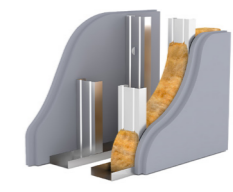

**Detail SOU 3**  
50 mm of Mada Glasswool insulation 16Kg/m3

System Ref.	Width (mm)	Stud (mm)	Section Detail	Board Configuration per Side	STC	Max. H (mm) / 0.24kPa	R <sub>w</sub> (dB)	Max. H (mm) / 0.20kPa
<b>60 Min Fire Rating</b>								
SOU111	160	48x0.55	SOU 2	2 x 12.5 Regular	63	2150	62	2400
SOU211	204	68x0.55	SOU 2	2 x 12.5 Regular	63	2450	62	2800
SOU311	264	98x0.55	SOU 2	2 x 12.5 Regular	63	3650	62	4100
SOU411	360	148x0.80	SOU 2	2 x 12.5 Regular	63	6050	62	6550
<b>120 Min Fire Rating</b>								
FIR115	146	48x0.55	FIR 2	3 x 16 Regular	61	3150	62	3650
FIR215	168	68x0.55	FIR 2	3 x 16 Regular	61	4150	62	4850
FIR315	198	98x0.55	FIR 2	3 x 16 Regular	61	5300	62	6200
FIR415	246	148x0.80	FIR 2	3 x 16 Regular	61	7350	62	8350
FIR113	125	48x0.55	FIR 2	3 x 12.5 Impact Resistant	62	3150	64	3650
FIR213	147	68x0.55	FIR 2	3 x 12.5 Impact Resistant	62	4150	64	4850
FIR313	177	98x0.55	FIR 2	3 x 12.5 Impact Resistant	62	5300	64	6200
FIR413	225	148x0.80	FIR 2	3 x 12.5 Impact Resistant	62	7350	64	8350
FIR423	225	148x0.80	FIR 3	3 x 12.5 Impact Resistant	62	7350	65	8350
SOU123	160	48x0.55	SOU 3	2 x 12.5 Impact Resistant	65	2150	65	2400
SOU223	204	68x0.55	SOU 3	2 x 12.5 Impact Resistant	65	2450	65	2800
SOU423	360	148x0.80	SOU 3	2 x 12.5 Impact Resistant	65	6050	65	6550
SOU117	160	48x0.55	SOU 2	2 x 16 Impact Resistant	68	2200	66	2450
SOU217	204	68x0.55	SOU 2	2 x 16 Impact Resistant	68	2500	66	2850
SOU417	360	148x0.80	SOU 2	2 x 16 Impact Resistant	68	6100	66	6600
<b>180 Min Fire Rating</b>								
FIR117	146	48x0.55	FIR 2	3 x 16 Impact Resistant	61	3150	65	3650
FIR217	168	68x0.55	FIR 2	3 x 16 Impact Resistant	61	4150	65	4850
FIR317	198	98x0.55	FIR 2	3 x 16 Impact Resistant	61	5300	65	6200
FIR417	246	148x0.80	FIR 2	3 x 16 Impact Resistant	61	7350	65	8350

Range minimized to aid selection. For other stud specifications and height requirements, please consult the system guide and contact Mada Technical Team.

## 5.2 Shaftwall Solutions

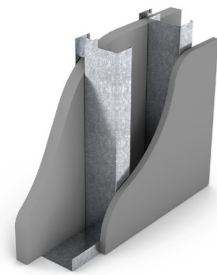

**Detail SHA 1**  
No insulation

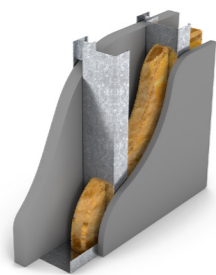

**Detail SHA 2**  
25 mm of Mada Glasswool insulation (16kg/m<sup>3</sup>)

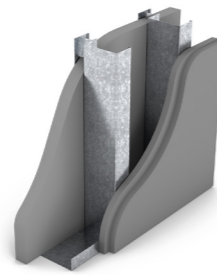

**Detail SHA 3**  
No insulation

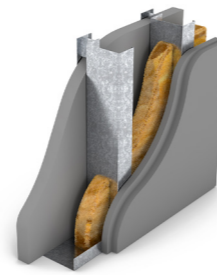

**Detail SHA 4**  
25 mm of Mada Glasswool insulation (16kg/m<sup>3</sup>)

System Ref.	Width (mm)	Stud (mm)	Section Detail	25mm Shaft Board side A + Board Configuration Side B	Insulation Thickness (mm)	STC	Max. H (mm) / 0.24kPa	R <sub>w</sub> (dB)	Max. H (mm) / 0.20kPa
<b>45 dB Range</b>									
<b>60 Min Fire Rating</b>									
SHA10S6	82	64x0.60	SHA 1	1 Layer of 16 Fire Resistant	*	44	4000	43	4400
SHA30S6	118	100x0.60	SHA 1	1 Layer of 16 Fire Resistant	*	44	5500	43	6100
SHA50S6	168	150x0.60	SHA 1	1 Layer of 16 Fire Resistant	*	44	5500	43	6100
SHA10S7	82	64x0.60	SHA 1	1 Layer of 16 Impact Resistant	*	45	4000	45	4400
SHA30S7	118	100x0.60	SHA 1	1 Layer of 16 Impact Resistant	*	45	5500	45	6100
SHA50S7	168	150x0.60	SHA 1	1 Layer of 16 Impact Resistant	*	45	5500	45	6100
SHA11S6	82	64x0.60	SHA 2	1 Layer of 16 Fire Resistant	25	47	4000	46	4400
SHA31S6	118	100x0.60	SHA 2	1 Layer of 16 Fire Resistant	25	47	5500	46	6100
SHA51S6	168	150x0.60	SHA 2	1 Layer of 16 Fire Resistant	25	47	5500	46	6100
SHA11S7	82	64x0.60	SHA 2	1 Layer of 16 Impact Resistant	25	48	4000	47	4400
SHA31S7	118	100x0.60	SHA 2	1 Layer of 16 Impact Resistant	25	48	5500	47	6100
SHA51S7	168	150x0.60	SHA 2	1 Layer of 16 Impact Resistant	25	48	5500	47	6100
<b>120 Min Fire Rating</b>									
SHA10S66	98	64x0.60	SHA 3	2 Layers of 16 Fire Resistant	*	48	4000	48	4400
SHA30S66	134	100x0.60	SHA 3	2 Layers of 16 Fire Resistant	*	48	5500	48	6100
SHA50S66	184	150x0.60	SHA 3	2 Layers of 16 Fire Resistant	*	48	5500	48	6100
SHA10S67	98	64x0.60	SHA 3	1 Layer of 16 Fire & 16 Impact Resistant	*	49	4000	49	4400
SHA30S67	134	100x0.60	SHA 3	1 Layer of 16 Fire & 16 Impact Resistant	*	49	5500	49	6100
SHA50S67	184	150x0.60	SHA 3	1 Layer of 16 Fire & 16 Impact Resistant	*	49	5500	49	6100
<b>50 dB Range</b>									
<b>60 Min Fire Rating</b>									
SHA11S66	98	64x0.60	SHA 4	2 Layers of 16 Fire Resistant	25	50	4000	50	4400
SHA31S66	134	100x0.60	SHA 4	2 Layers of 16 Fire Resistant	25	50	5500	50	6100
SHA51S66	184	150x0.60	SHA 4	2 Layers of 16 Fire Resistant	25	50	5500	50	6100
SHA11S67	98	64x0.60	SHA 4	1 Layer of 16 Fire & 16 Impact Resistant	25	51	4000	51	4400
SHA31S67	134	100x0.60	SHA 4	1 Layer of 16 Fire & 16 Impact Resistant	25	51	5500	51	6100
SHA51S67	184	150x0.60	SHA 4	1 Layer of 16 Fire & 16 Impact Resistant	25	51	5500	51	6100

Range minimized to aid selection. For other stud specifications and height requirements, please consult the system guide and contact Mada Technical Team.

## 5.3 Wall Linings

### 5.3.1 - Dot & Dab

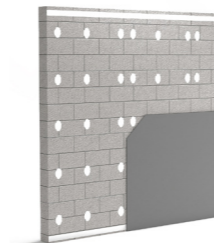

As one of the original systems for using adhesive for drylining masonry walls, the dot & dab system has been tried and tested in every sector and remains one of the narrowest solutions for creating a cavity for MEP whilst producing a consistently smooth finish.

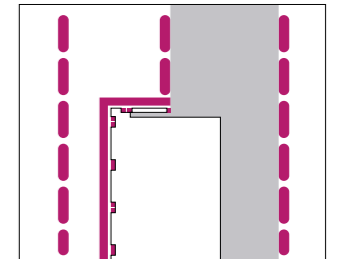
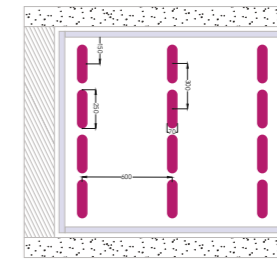

### 5.3.2 - Braced Liner

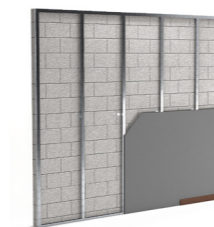

here the existing substrate is not suitable for a directly bonded solution, a frame is required to support the lining. This liner system braces to the background to allow for minimal width build-ups and allows for acoustic upgrades to the existing wall.

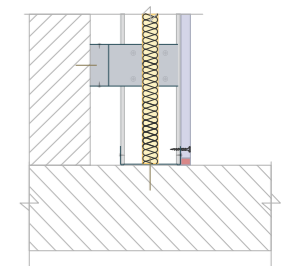
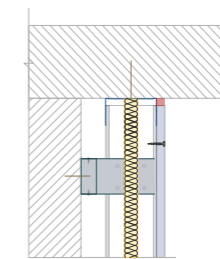

### 5.3.3 - Independent Liner

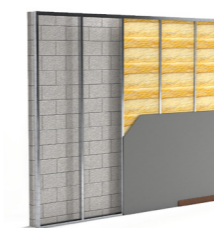

As one of the original systems for using adhesive for drylining masonry walls, the dot & dab system has been tried and tested in every sector and remains one of the narrowest solutions for creating a cavity for MEP whilst producing a consistently smooth finish.

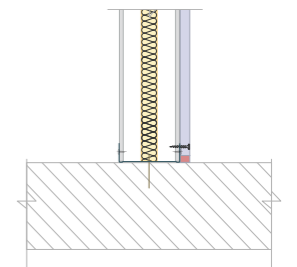
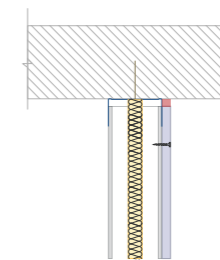



5.3.3 - Independent Liner (continued)

45 dB Range\*

System Ref.	Width (mm)	Stud (mm)	Board Configuration on one side	STC	Max. H (mm) / 0.24kPa	R <sub>w</sub> (dB)	Max. H (mm) / 0.20kPa
ILS101	62.5	48x0.50	1 x 12.5 Regular	47	2150	47	2400
ILS102	62.5	48x0.50	1 x 12.5 Fire Resistant	48	2150	47	2400

50 dB Range\*

System Ref.	Width (mm)	Stud (mm)	Board Configuration on one side	STC	Max. H (mm) / 0.24kPa	R <sub>w</sub> (dB)	Max. H (mm) / 0.20kPa
ILS201	82.5	68x0.50	1 x 12.5 Regular	50	2550	49	2800
ILS202	82.5	68x0.50	1 x 12.5 Fire Resistant	51	2550	50	2800
ILS301	112.5	98x0.50	1 x 12.5 Regular	52	4000	51	4250
ILS204	82.5	68x0.50	1 x 12.5 ProGuard	52	2550	51	2800
ILS205	86	68x0.50	1 x 16 Regular	52	2550	51	2800
ILS206	86	68x0.50	1 x 16 Fire Resistant	52	2550	51	2800
ILS305	116	98x0.50	1 x 16 Regular	53	4000	52	4250
ILS203	82.5	68x0.50	1 x 12.5 Impact Resistant	53	2550	52	2800
ILS209	82.5	68x0.50	1 x 12.5 Procem	53	2100	52	2350
ILS303	112.5	98x0.50	1 x 12.5 Impact Resistant	54	4000	53	4250
ILS304	112.5	98x0.50	1 x 12.5 ProGuard	53	4000	53	4250
ILS309	112.5	98x0.50	1 x 12.5 Procem	54	3700	53	3950
ILS201	95	68x0.50	2 x 12.5 Regular	54	2850	53	3100
ILS301	125	98x0.50	2 x 12.5 Regular	55	4300	54	4550

55 dB Range\*

System Ref.	Width (mm)	Stud (mm)	Board Configuration on one side	STC	Max. H (mm) / 0.24kPa	R <sub>w</sub> (dB)	Max. H (mm) / 0.20kPa
ILS211	82.5	68x0.50	1 x 12.5 Regular	56	2550	55	2800
ILS221	82.5	68x0.50	1 x 12.5 Regular	56	2550	55	2800
ILS203	95	68x0.50	2 x 12.5 Impact Resistant	55	2850	55	3100
ILS204	95	68x0.50	2 x 12.5 ProGuard	55	2850	55	3100
ILS311	112.5	98x0.50	1 x 12.5 Regular	57	4000	56	4250
ILS319	112.5	98x0.50	1 x 12.5 Procem	56	3700	56	3950
ILS304	125	98x0.50	2 x 12.5 ProGuard	56	4300	56	4550
ILS219	82.5	68x0.50	1 x 12.5 Procem	56	2100	56	2350
ILS314	112.5	98x0.50	1 x 12.5 ProGuard	57	4000	57	4250
ILS311	125	98x0.50	2 x 12.5 Regular	57	4300	57	4550
ILS214	82.5	68x0.50	1 x 12.5 ProGuard	57	2550	57	2800
ILS211	95	68x0.50	2 x 12.5 Regular	57	2850	57	3100

\*Acoustic performance includes blockwork.

5.4 Monolithic Ceilings

5.4.1 - Metal Framing Ceiling

The most common solution for creating simple, cost-effective, monolithic ceilings, Mada Metal Framing Ceiling is highly adaptive being able to offer fire-rated solutions and high-performance acoustic mass barrier configurations.

5.4.1.1 - Angle Fixation

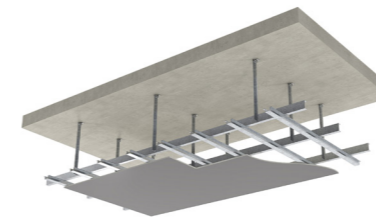

No Fire Rating

**Board Thickness**  
Layers of 12.5 Mada Regular Plasterboard

**Main Channel Centers**  
900mm

**Furring Channel Centers**  
400mm

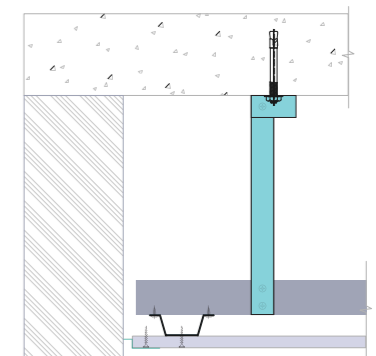

5.4.1.2 Threaded Rod Fixation

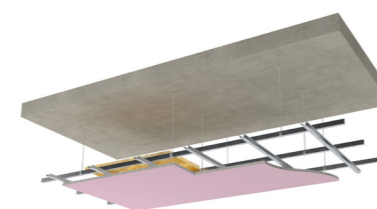

**1 Hour Fire Rated Solution**  
Fire rating EN1364-2: 60 min

**Board Thickness**  
2 Layers of 16 Fire Resistant

**Insulation**  
50mm Rockwool (40kg/m<sup>3</sup>)

**Main Channel Centers**  
900mm

**Furring Channel Centers**  
400mm

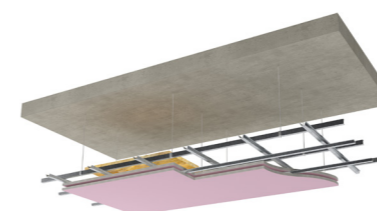
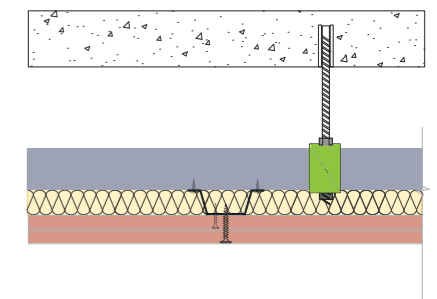

**2 Hours Fire Rated Solution**  
Fire rating EN1364-2: 120 min

**Board Thickness**  
4 Layers of 16 Fire Resistant

**Insulation**  
50mm Rockwool (40kg/m<sup>3</sup>)

**Main Channel Centers**  
900mm

**Furring Channel Centers**  
400mm

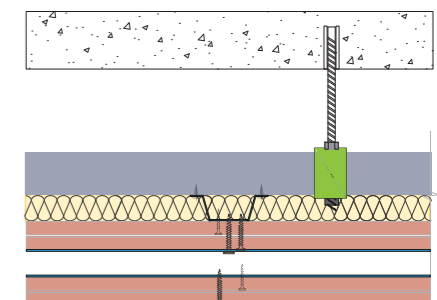

5.4.2 - Corridor Spanning System

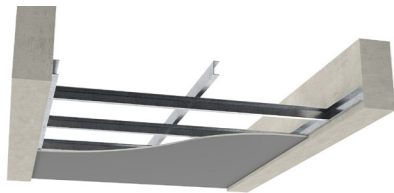

Horizontal Frame	Centres (mm)	Thickness (mm)	Span (mm)
			1 layer of 15mm board
48mm 'C' stud	400	0.55	1900
		0.9	2200
	300	0.55	2150
		0.9	2350
68mm 'C' stud	400	0.55	2400
		0.9	2700
	300	0.55	2950
		0.9	3400
98mm 'C' stud	400	0.55	3500
		0.9	3750
	300	0.55	3800
		0.9	4050
148mm 'C' stud	400	0.8	5050
		0.9	5350
	300	0.8	5300
		0.9	5800



5.5 Exterior Envelop

Mada ProGuard glass mat sheathing is an ideal light-weight solution for exterior envelop, offering ease to install, moisture and mold resistance, Class A fire resistance, designed for use under Exterior Insulation Finish Systems (EIFS), exterior claddings like brick veneer, marble cladding, siding systems, porcelain tiling and conventional stucco or direct render.

Indicative Framing & Insulation	Fire Rating	Boarding	Finish Options			
			Direct Render		Insulated Render (IFS)	
			Thickness (mm)	U-value (W/m <sup>2</sup> K)	Thickness (mm)	U-value (W/m <sup>2</sup> K)
100mm Stud with 90mm infill (Density 50kg/m <sup>3</sup> )	60 min	External: 1x16mm ProGuard Internal: 1x16mm Impact Resistant	132	0.345	182	0.229
	120min	External: 2x16mm Impact Resistant Internal: 1x12.5mm ProGuard	157		207	
125mm Stud with 100mm in fill (Density 50kg/m <sup>3</sup> )	60 min	External: 1x16mm ProGuard Internal: 1x16mm Impact Resistant	157	0.315	207	0.215
	120min	External: 2x16mm Impact Resistant Internal: 1x16mm ProGuard	182		232	
150mm Stud with 120mm in fill (Density 50kg/m <sup>3</sup> )	60 min	External: 1x16mm ProGuard Internal: 1x16mm Impact Resistant	182	0.268	232	0.192
	120min	External: 2x16mm Impact Resistant Internal: 1x12.5mm ProGuard	207		257	

Cladding

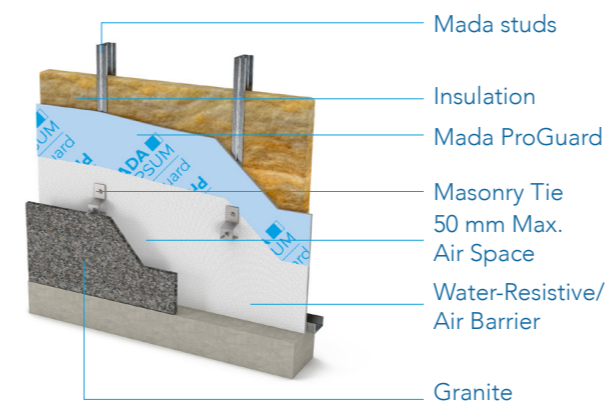

Stucco Direct Rendering

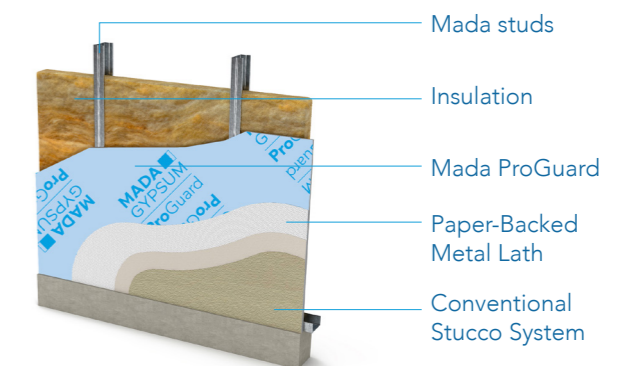

## 5.6 Sector Specified Details

### 5.6.1 - Fixing Detail for Additional Attachment

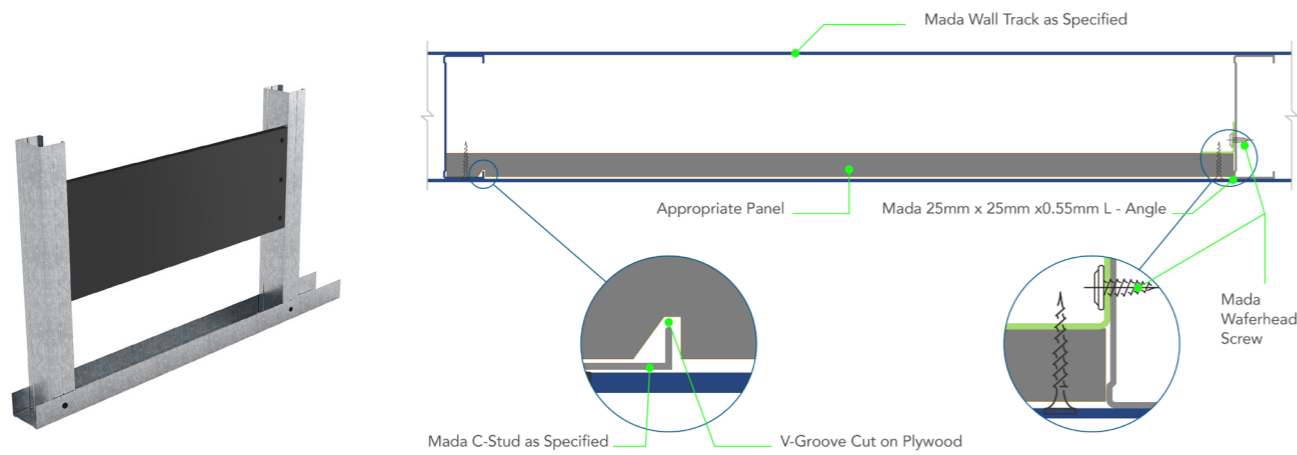

### 5.6.3 - Mounting Handrail and Crash Rail Protection Detail

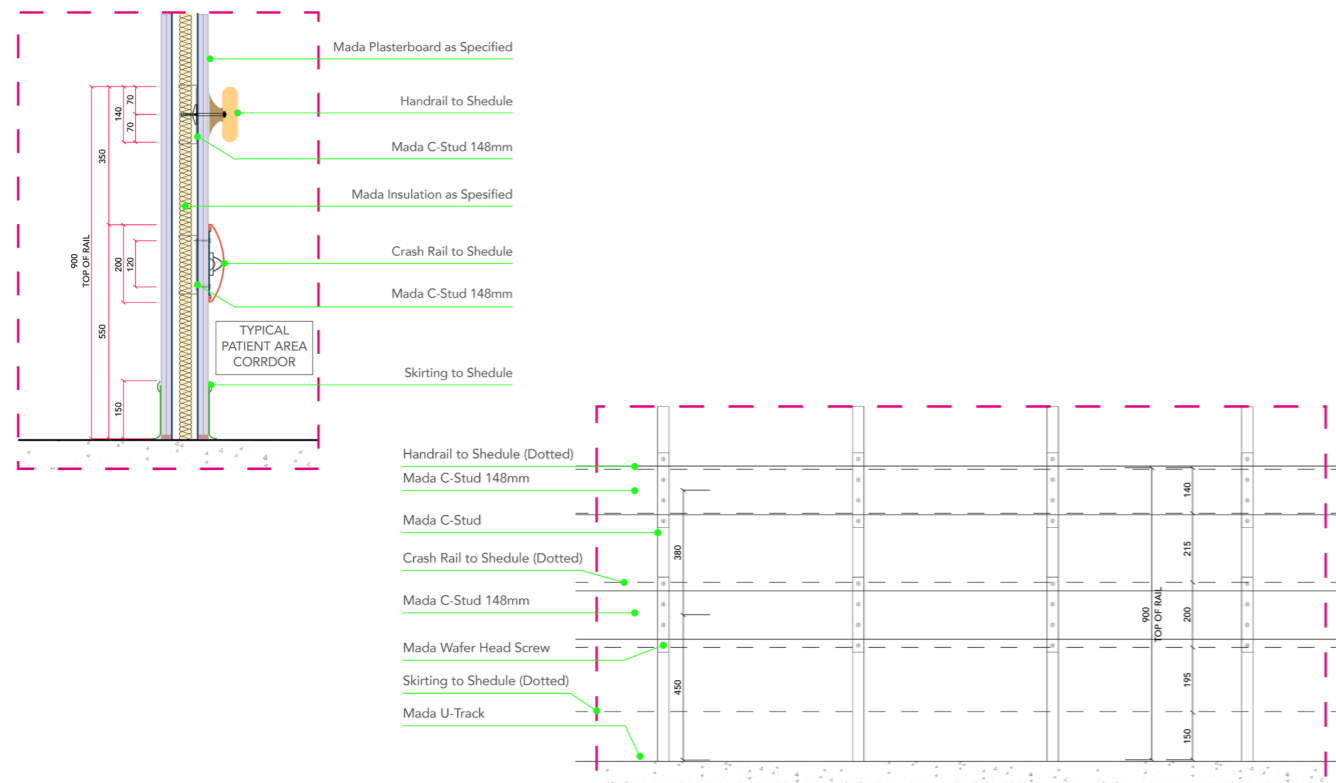

### 5.6.3 - Plan of Typical Fixing Detail for Electric Switch Box with Putty Pad

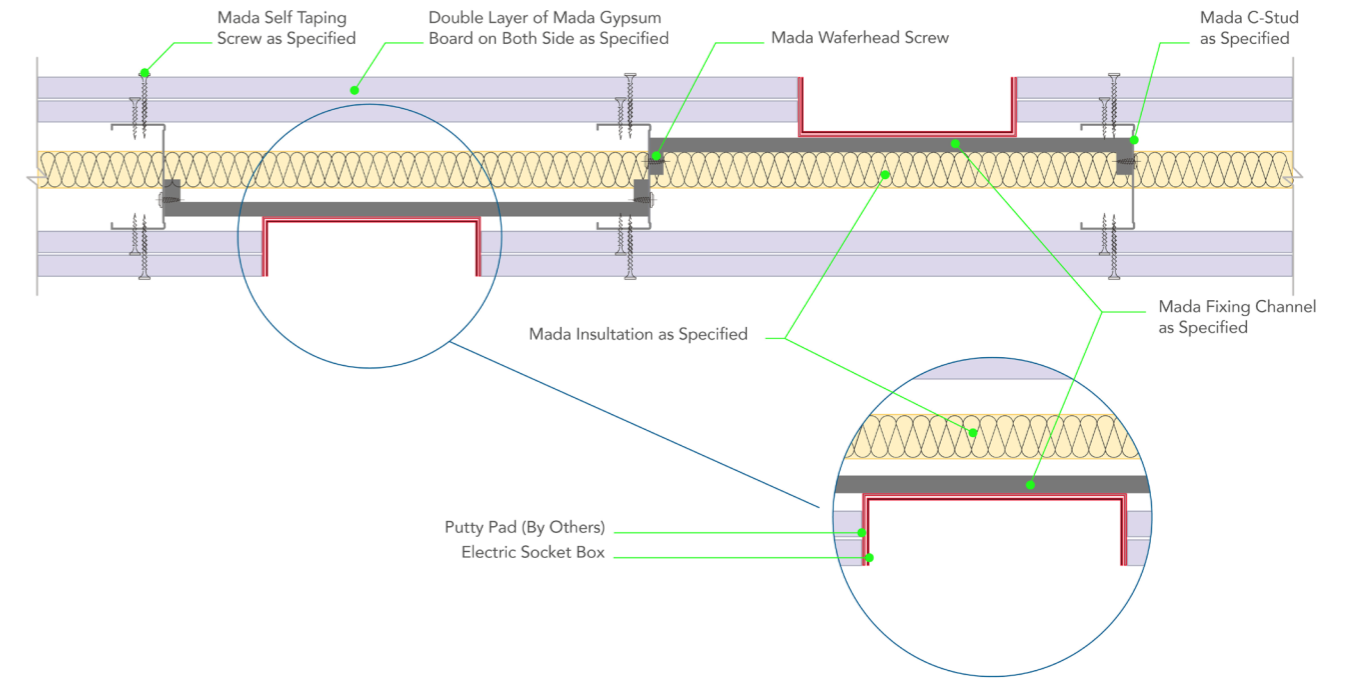

### 5.6.4 - Plan of Typical Fixing Detail for Electric Switch Box

Electric boxes should be installed offset from each other on the two sides of a partition wall, not back to back.

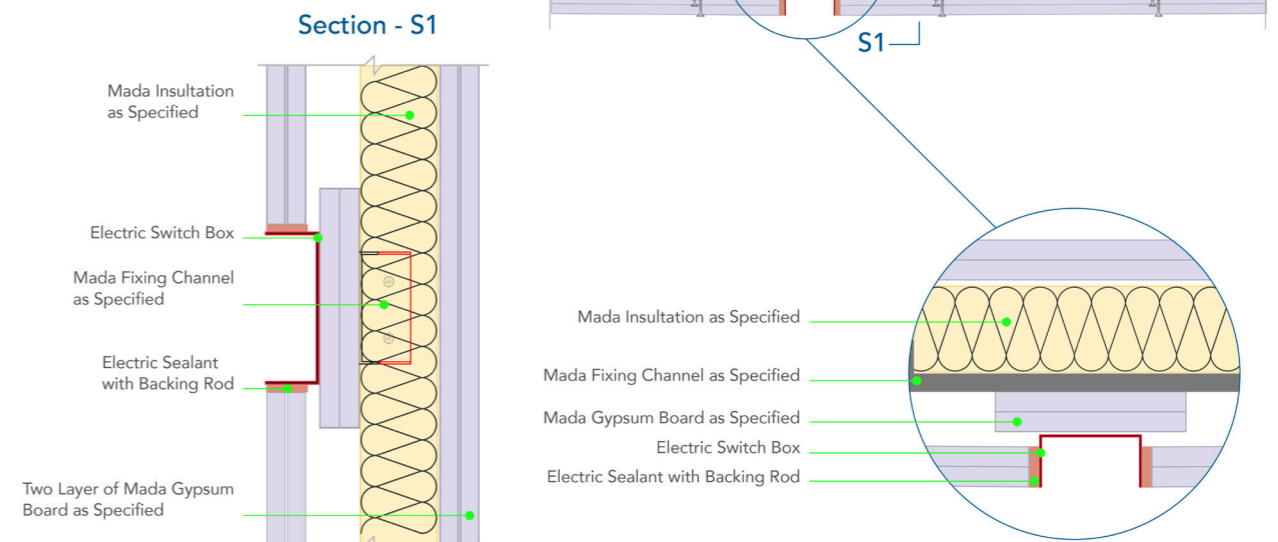

**5.6.5 - Standard Door Fixing Details - Up to 25Kg Door Weight**

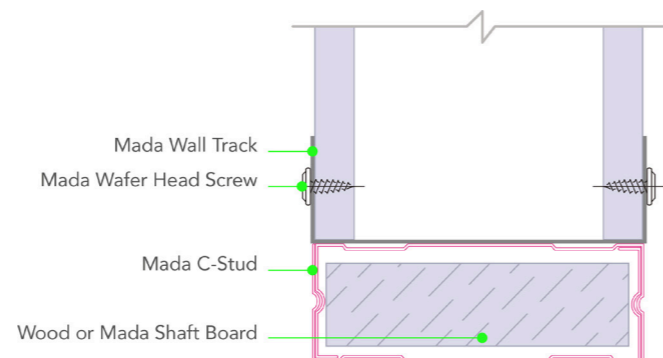
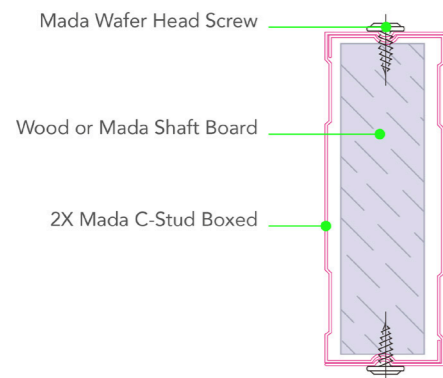
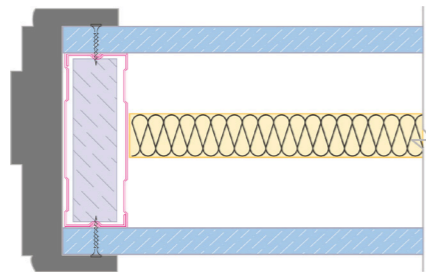
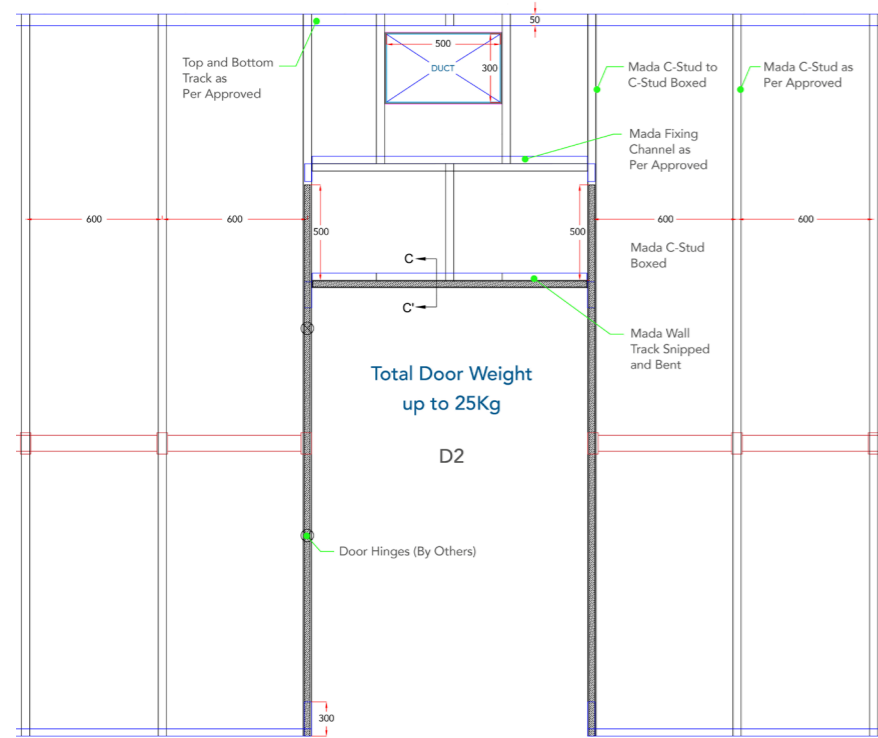

**5.7 Finishing and Accessories**

Mada offers a wide range of finishing solutions for the Educational Sector, giving additional liability to the performance of the system proposed to benefit from the Mada Warranty:

**5.7.1 - Mada Plus Fixings | High quality steel fixings from MADA Gypsum**



**Mada PLUS Wedge Anchors**  
Galvanized steel expansion anchors used for fixing hangers, brackets, and drywall profiles to concrete backgrounds.



**Mada PLUS Drop-in-Anchor**  
Drop-In-Anchors are an all-steel, medium duty expansion anchor designed to provide a permanent anchorage point in concrete substrates. An internal thread allows for use with both machine bolts and threaded rod, with no restrictions on fixture thickness.

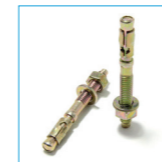

**Mada PLUS Trublot Anchor**  
Trubolt Stud Anchors are true-to-size, heavy duty, torque-controlled expansion anchors, for permanent anchoring into concrete substrates.



**Mada PLUS Plastic Nail Plug**  
Galvanized steel expansion anchors used for fixing hangers, brackets, and drywall profiles to concrete backgrounds.

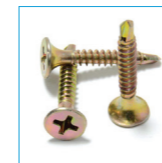

**Mada PLUS Drywall Screws**  
Corrosion-resistant screws with bugle head for fixing plasterboard to metal studs up to a steel thickness of 0.80mm.

**Available Lengths**  
25mm | 35mm | 42mm | 50mm | 62mm

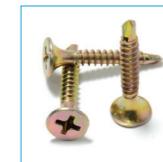

**Mada PLUS Self Drilling Screws**  
Corrosion-resistant screws with bugle head and self-drilling tip for fixing plasterboard to metal studs above 0.80mm thick.

**Available Lengths**  
25mm | 35mm | 45mm | 50mm | 60mm | 65mm

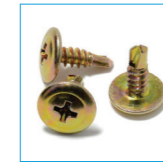

**Mada PLUS Wafer Head Screws**  
Corrosion-resistant screws for fixing metal framing members together.

**Available Lengths**  
13mm

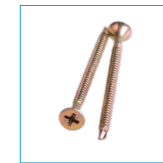

**Mada PLUS PROCEM Steel Drill Screws**  
Corrosion-resistant screws with countersunk head, specially designed ribs under the head and self drilling tip for fixing Mada PLUS PROCEM cement boards to metal studs.

**Available Lengths**  
25mm | 35mm | 45mm | 50mm | 60mm



**Mada PLUS Hex Head Self Drilling Screws**  
Corrosion-resistant screws specially designed for fixing metal to metal with a thickness of 0.8mm up to 3.0mm.

**Available Lengths**  
19mm | 25mm | 50mm

**5.7.2 - Mada Plus Finishing Products** | High quality, approved finishing products you can trust



**Mada Fiber Joint Tape**

Mada Fiber Joint Tape is composed of twisted strands of fiber glass woven at right angles to one another and used for reinforcing drywall joints. Suitable for hand or mechanical application with Mada Gypsum's Jointing Compound.



**Mada PLUS PROCEM CEMENT Jointing Compound**

Mada PROCEM Cement Jointing Compound is a 2-component high-adhesion, high-flexibility jointing material. A powder based on special cement and a secondary, liquid-based, acrylic polymer element with fibers and special additives. Used for jointing and finishing Mada PLUS PROCEM cement board.



**Mada Multi-Use Jointing Compound**

Mada Multi-Use Jointing Compound contains vinyl binders and other ingredients that provide superior performance compared to ordinary ready mix products. Can be used directly from pail and requires minimal mixing, thinning, and re-tempering.



**Mada French Adhesive**

Mada French Adhesive is a special gypsum product for adhering decorations and cornices to walls, and the installation of plasterboard on a dot and dab system.

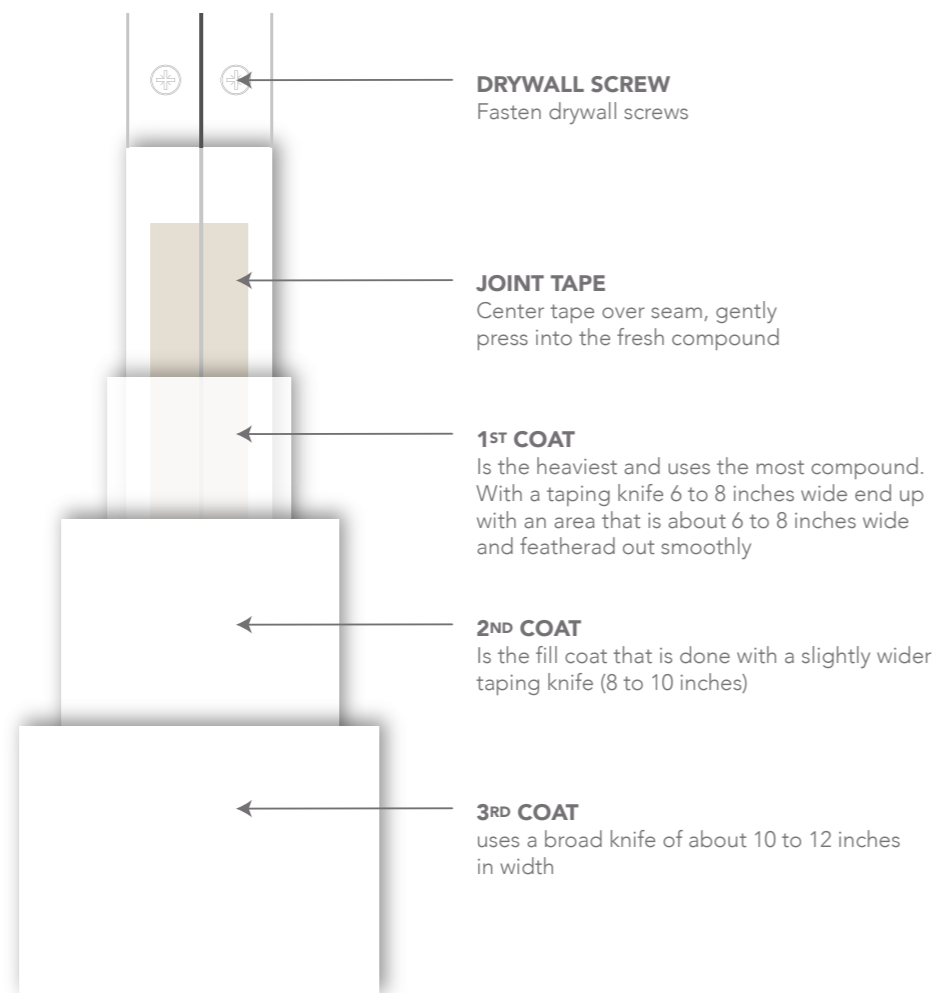

**5.7.3 - Mada Plus Approved Insulation** | Find the right insulation solution for your project



**Glasswool Insulation**

An insulating material consisting of fine, long, inorganic fibers bonded together by a high-temperature binder. Excellent acoustic properties, lightweight, high-tensile strength, with exceptional resilience.



**Rockwool Insulation**

Rockwool is an insulating material manufactured from natural minerals such as basalt, which are melted at very high temperatures and spun using advanced production techniques. The fibers are then bonded with a thermosetting resin binder and special additives. It has good thermal and acoustic properties, is lightweight and strong, and classed as non-combustible when tested to BS:476.

**5.7.4 - Mada Plus Accessories** | Explore our comprehensive range of accessories



**Mada PLUS C-Clamp**

Mada C-Clamp is designed to hold the primary ceiling channel to the soffit via threaded rod. This C-Clamp can accommodate 38mm and 45mm Mada Main channels.

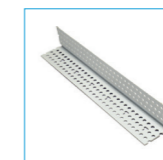

**Mada External Corner Beads**

Mada External Corner Beads are used for straight, durable, corrosion and impact-resistant protection of the edges and corners of drywall systems.



**Threaded Rod**

Threaded rods for suspending ceilings. One end fixes to the concrete slab/beams or any other structure with suitable fixings, the other end attaches to the ceiling framework. Designed to be used in high tensions, the thread runs along the entire length of the rod. Available in M<sup>6</sup>, M8 and M10 sizes.



**Mada Casin Bead**

Mada Casing Beads are squared corner beads that fit firmly over the edge of the plasterboard for protection against impact. A range of casing beads are available to fit different plasterboard thicknesses.

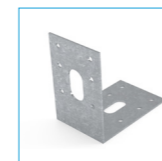

**Mada PLUS L-Bracket**

Mada PLUS L-Brackets for supporting C-studs at the floor and soffit. Suitable for use in Mada PLUS partitions, Mada PLUS lining systems, and Mada PLUS suspended ceilings.



**Mada Shadow Gap Angle Bead**

Mada Shadow Gap Angle Bead provides straight and neat finishing details for the internal corners of Mada PLUS suspended ceiling systems.



**Mada PLUS Slotted L-Bracket**

Slotted L-Brackets are designed to resist high moments and shear due to excessive loading, such as live loads, as well as seismic and wind pressures. Vertical slots on the bracket allow the slab to deflect without impacting the performance or structural integrity of the partition.



**Mada PLUS Control Joint Bead**



Mada Shadow Gap Angle Bead provides straight and neat finishing details for the internal corners of Mada PLUS suspended ceiling systems.



**Mada Sealants**

Mada FireGuard Sealant An acrylic-based caulk that is resistant to water and mild chemicals, and contains anti-microbial protection to inhibit the growth of mold and mildew. Mada Fire Guard - Fire and Acoustic Silicone Sealant A single component, neutral cure, elastomeric, gun-grade, high performing fire stopping sealant.

## 5.7.5 - Renders

	 Thin Coat Render	 Hand Applied Render	 Machine Render
Type of render	Grey-white gypsum based render	Grey-white gypsum based render	Render with a glossy surface
Description	Thin coat render with a smooth surface	Render with a smooth surface	Render with a smooth surface
Composition	Stucco, additives to improve adhesion to base material	Stucco, additives to improve adhesion to base material	,Stucco, Lime, sand perlite and additives to improve adhesion to base material
Usage	Interior walls, ceilings at temperatures above C° 5+	Interior walls, ceilings at temperatures above C° 5+	Interior walls, ceilings at temperatures above C° 5+
Workability Time	mins 60 > – Manual	mins 45 > – Manual	mins 120 > – Machine
Coverage	mm 0.9	mm 0.8	mm 1.0
Base surface material	Concrete, Porous Concrete, Render	,Brickwork, Concrete Porous Concrete, Render	Brickwork, Porous Concrete, Render
Recommended render thickness	mm 6 – 3	mm 30 – 5	mm 6 ≤
Surface finish	Paint, Wallpaper	Paint, Wallpaper	Paint, Wallpaper, Tiles
Packaging	kg bag 40	kg bag 40	kg bag 40
Storage term	months 12	months 12	months 12

Head Office: P.O.Box 31542, Yanbu Al Sinayah 51000 Kingdom of Saudi Arabia  
Tel.: + 966 14 325 3253 | Fax: + 966 14 325 0420

UAE: +971 4 338 0818 | Bahrain: +966 53 333 0480  
Egypt: +20 128 215 3521 | Other Countries: +966 55 536 1370

[www.madagypsum.com](http://www.madagypsum.com)

# Healthcare Sector

Head Office: P.O.Box 31542, Yanbu Al Sinayah 51000 Kingdom of Saudi Arabia  
Tel.: + 966 14 325 3253 | Fax: + 966 14 325 0420