



EDUCATIONAL SECTOR

December 2022



Issue No. 01

Table of Content

General Design Considerations	4
Fire Safety	5
Acoustics	6
Structure	9
Service Integration	11
Sector Focus	13
Robustness	13
Visual Aesthetics	13
Speech Clarity	14
Versatility	18
Solution Selection	19
Partitions	20
Shaftwall Solutions	30
Wall Linings	31
Monolithic Ceiling	33
Exterior Envelop	35
Sector Specified Details	36
Finishing and Accessories	39



Innovation is continuously changing how education will be delivered in the future.

Introduction



01

-
Functionality



02

-
Efficiency



03

-
Sustainability



04

-
Integration



05

-
Safety

With a projected 23% rise in the number of people in the MENA region who will be of school age by 2030, there will be 25 million more learners to accommodate in the educational system.

All nations have consistently prioritized education and made significant efforts to create an environment that complies with, and exceeds international norms. Innovation is continuously changing how education will be delivered in the future. The educational system will be substantially redesigned due to the rapid advancement of technology in the upcoming ten years. As a result of this transformation, educational building designs are adjusting, and the following factors are being considered in educational spaces:

Functionality

Classrooms will need to be more practical. Form and function must be compatible.

Efficiency

Maximal energy efficiency will be achieved in building designs. A few strategies architects and builders are using to make their buildings more energy efficient include insulation, exposure, ventilation, alternative energy, and space.

Sustainability

Ensuring that the buildings they construct are long-term sustainable is one of the main issues facing designers and builders in the current era. The idea behind this is to determine whether concepts are appropriate for a given project and whether the use of specific materials is justified, rather than to push the boundaries of building design concepts and the materials required to make them a reality.

Integration

The period of unfettered building design is coming to an end as most people live in developed cities and the nearby suburbs. The necessity of integrating building design and construction into the surrounding environment, including WiFi connectivity, smart boards and walls, lines of sight, clarity of speech, areas of planned and unplanned cooperation, and more, must be highly emphasized in educational environments.

Safety and emergency response

Pertaining to the speed and safety with which occupants of the building can be evacuated in the event of an emergency.

The Mada Educational Guide's objective is to provide designers, architects, and contractors with access to the standards, considerations, and solutions that the technical team at Mada Gypsum Company has to offer in relation to the educational sector's use of partitions and ceiling systems.

Mada's technical staff is constantly ready to help, from design to implementation and handover, as each educational facility always has its own uniqueness.

General Design Considerations

3

Educational facilities are becoming more specialized, which is a typical trend across many building types. For instance, we now know that preschool classes are fundamentally different from those designed for high school seniors or the instruction of mid-career professionals. Even the traditional conception of the “classroom” as a learning environment focused on the instructor is evolving nowadays. We must reevaluate conventional educational patterns and spatial linkages considering the expansion of computer-based instruction, video projection, and other communications requirements.

Concerns about the health and well-being of pupils, especially young ones, are piquing interest in bettering the efficiency and fabric of school buildings from an environmental standpoint. The use of ecological and non-toxic construction materials, daylighting, and renewable energy sources are all becoming more popular in school design. Resources for building, maintaining, and caring for educational facilities are still in low supply.

The American Whole Building Design Guide - Educational Facilities (www.wbdg.org) segregates educational institutions as follows:

- Child Development Centers, including preschool and day-care
- Elementary, including K through 8th grade
- Secondary, including high school and junior college
- University, including college and post-graduate education
- Training, including computer centers and teleconference facilities

Each building type’s attributes are addressed in terms of:

- Types of Spaces
- Design Considerations
- Accessibility
- Aesthetics
- Cost Effectiveness
- Functionality
- Historic Preservation
- Productivity
- Security / Safety
- Sustainability

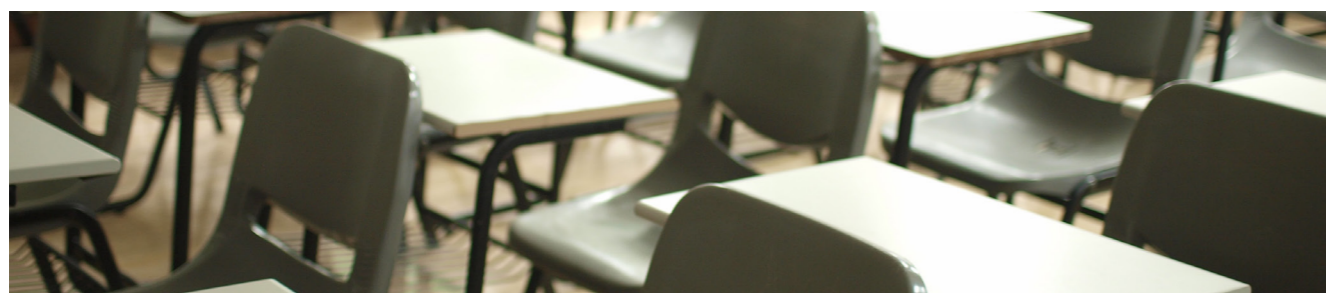

3.1 Fire Safety

When considering if a material is safe to be used inside a modern building, it is important to consider its reaction to a fire.

Materials inside a building can significantly affect the spread of fire and its growth rate, even though they are most likely not the source of the original ignition. Therefore, the correct selection of materials is an essential part of fire safety, and the choice of linings and coverings is critical in:

- Circulation spaces where adjoining surfaces provide the primary means for fire to spread.
- Areas (hallways, lobbies, and stairs) where rapid spread is most likely to prevent occupants from exiting the building.

Designers and architects should focus attention on two critical properties of lining materials that influence fire spread:

- The rate flame spreads over the surface when subjected to an intense radiant heating source.
- The rate at which the tested material gives off heat when burning.

3.1.1 - Compartmentation

Compartmentation strategies (separating sub-assemblies using fire-resistive construction techniques) can effectively reduce or restrict the building's risk of fire spread.

Two key objectives of compartmentation are:

- To prevent rapid fire and smoke spread, potentially trapping occupants in the building.
- To reduce the chance of fires growing in size and temperature, which could affect occupants, fire service personnel, and people in the vicinity of the building.

Determining the level of compartmentation needed depends on three key factors:

- i The building’s use and fire load, which affects the potential for and the severity of a fire and building evacuation strategies.
- ii The height to the top story of the building indicates the ease of evacuation and the accessibility for firefighters and first responders.
- iii The building code standards of the Authority Having Jurisdiction (AHJ) over the project permits and inspections.

Time Temperature Curve for Fire-Endurance Testing

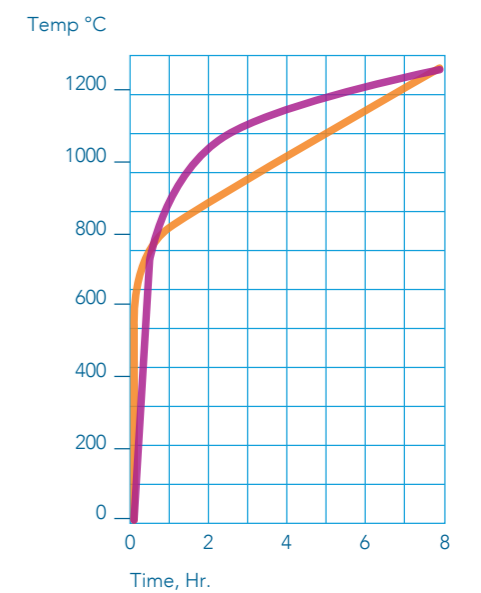

BS 476: Part 20: 1987
ASTM E119

3.2 Acoustics

3.2.1 - Acoustics and Sound Insulation

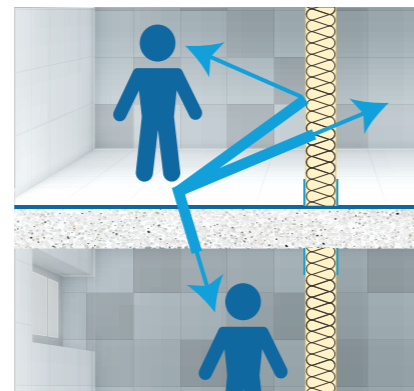
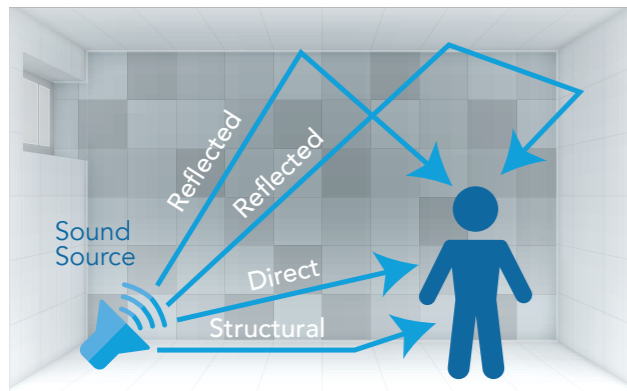

Figure 1: Impact sound can affect those within spaces as airborne sound, and those in other parts of the building as structure born sound

The control of noise levels and the sound characteristics within a space and noise transmission from one area to another is known as Building Acoustics. Noise can be an undesirable sound, but this is subjective and depends on the individual. Unpleasant sounds can reduce the occupant’s comfort and efficiency, and long-term exposure can cause physical discomfort and mental distress.

Sound insulation refers to the process of reducing sounds that moves from one defined space to another, separated by a dividing element. Direct transmission occurs when sound travels through the dividing element. Indirect transmission (flanking) refers to sound traveling through the adjoining building structure. An effective sound insulation solution will address both types of sound transmission.

Sound insulation requirements must consider both internal and external sound transmission sources to be completely effective. Building Acoustics includes two distinct components, sound insulation, and sound absorption.

3.2.2 - Guide to sound insulation levels for speech privacy

STC	Speech privacy
25 dB	Normal speech can be heard quite easily and distinctly
30 dB	Loud speech can be understood fairly well; Normal speech can be heard but not understood
35 dB	Loud speech can be heard but not intelligible
42 dB	Loud speech is audible as a murmur
45 dB	Loud speech is not audible
50 dB	Very loud sounds such as musical instruments or a stereo can be faintly heard
65 dB	Very loud speech cannot be heard
75 dB	Extremely loud speech cannot be heard

Sound absorption occurs when sound waves contact an absorbent surface such as a wall, ceiling, or floor and don’t reflect any sound back into the space, is sound absorption. Products and materials fall into classes ranging from A (the best) through E, based on their sound absorption abilities when tested.

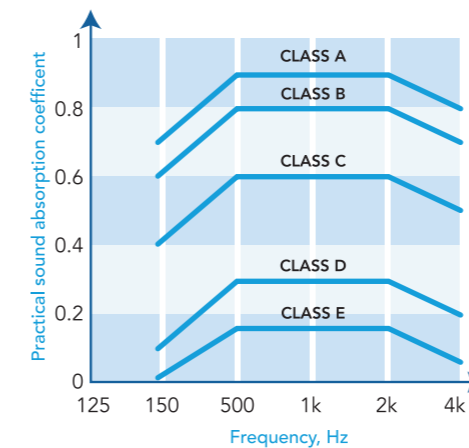

Illustration of the reference curve limiting the different sound absorption classes, from BS EN ISO 11654: 1997.

Sound and noise levels get expressed in either: Decibels (dB) - a logarithmic unit used to measure sound level, or Hertz (Hz) – measures the frequency of the wave.

As the ear detects changes in sound pressure, they become electrical impulses and get sent to the brain. The brain converts the impulses to auditory signals, allowing us to hear sound and noise between the 20 Hz and 20,000 Hz range.

Humans interpret a 10 dB increase as doubling the sound level, which explains why a pneumatic drill (100 dBA) seems four times louder than a person shouting (80dBA). And why a 10 dBA reduction in the sound level makes an area seem 50% quieter.

In humans, the optimum hearing occurs in the speech range, or middle-frequency sounds ranging from 500 Hz to 4,000 Hz. Hearing ability can vary from one individual to the next, depending on age, physical health, or previous long-term exposure to excessive noise.

Sound level dBA (log scale)	Sound Source
0	Threshold and audibility
20	Whisper
30	Quiet conversation
40	Background noise in unoccupied office
50	Normal conversation
60	Occupied offices
70	Inside a travelling railway carriage
80	Road side, busy street
100	Inside a nightclub
120	Jet aircraft taking off 100m away or MP3 player at maximum volume
120-130	Threshold of pain
140>	Damage to hearing



3.2.3 - Noise Leakage

The diminished acoustic performance will result if there are any cracks or gaps from one building service/component/assembly to another, as sound can quickly move through the air from one area to another. Here are a few of the most common noise leakage culprits.

- Wall and floor openings where distribution services such as wiring, pipes, or ducts pass from one area to another.
- Continuous curtain walling or internal lining system installations.
- Perimeter junctions and joints where partitions, raised floors, and ceilings meet one another.
- Door vents and keyholes, the edges of improperly fitted doors, and thresholds without an acoustic seal.
- Air handling luminaires (grills and registers) in the suspended ceiling connecting to a common air supply/return plenum supplying adjacent areas.
- Recessed lighting fixture troughs that span across the top of a shared partition.
- Air ducts installed above the ceiling or below a raised floor supply air services to two or more areas.

3.2.4 - Indirect Sound Paths (Flanking Transmission)

Small gaps, cracks, holes, or other openings allow air-bound sound to travel to adjacent areas, reducing overall acoustic performance. Therefore, maximum sound transmission control requires an airtight seal around all penetrations. Use Mada Acoustical Sealant for small gaps and cracks, and for gaps greater than 5mm, where wallboards meet either the ceiling or floor surfaces, use Mada Jointing Compound.

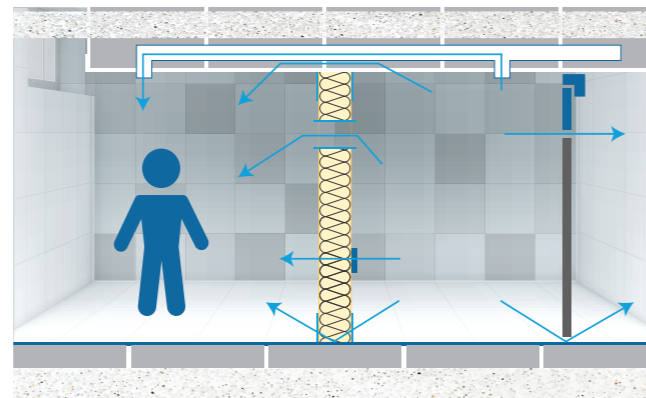
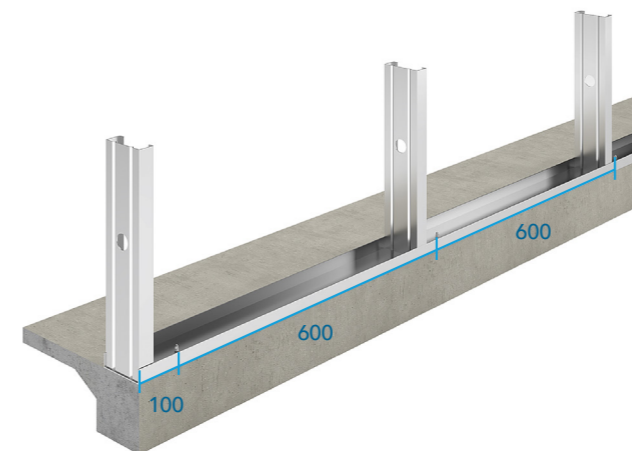

Figure 2: Typical flanking paths around partitions

3.3

Structure

Mada wall and ceiling framing systems are designed and manufactured to meet the most demanding job site requirements and applicable building codes. A safe and effective framing system must meet/exceed the structural requirements for wind, live & dead loads, and other project-specific types of potential loading.



Safe and effective wall design should allow for the following factors and considerations:

- Loadings created by potential external/internal pressure differences
- Vertical loads
- Adequate support for wall-mounted accessories and materials such as shelves, cabinets, and siding
- Vertical deflection resulting from movement of the building
- Proper support of windows/door openings (including lateral support)
- Thermal expansion from fire or excessive heat

Mada steel frame design solutions consider the following basis:

- Allowable Strength Design (ASD)
- Load and Resistance Factor Design (LRFD)
- Load Combinations

Typical additional considerations include:

- Local Buckling, Distortional Buckling, and Post-buckling Strength of Thin Compression Elements
- Torsional Rigidity
- Variable Properties of Sections Having Stiffened or Unstiffened Compression Elements
- Connections
- Web Crippling Strength

3.3.1 - Maximum Wall Heights

Non-load bearing steel stud framing systems must not exceed the heights given in the Framing Systems Section.

Maximum heights consider the maximum allowable deflection at mid-point.

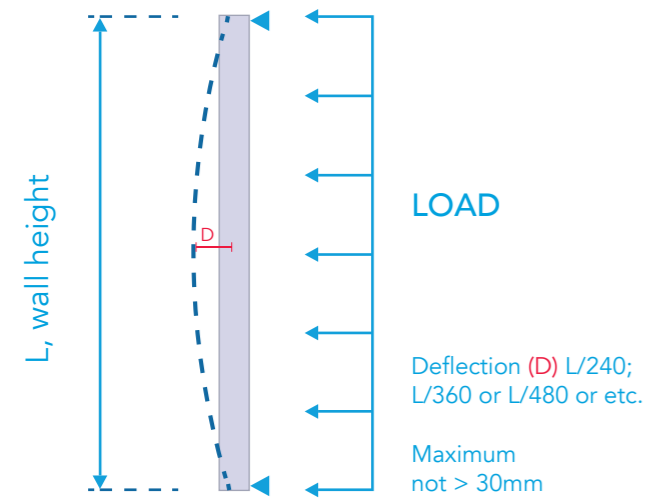

The maximum height for non-loadbearing walls has been provided for:

SBC compliance - 0.25KPa lateral pressure and based on L/240 (deflection criteria) per the NCC.

International Industry Standard – 0.2KPa lateral pressure and based on L/240 (deflection criteria) per the NCC.

Additionally, finishes or loads may indicate the acceptable level of mid-point deflection. For example:

- L/240
 - General partition
 - Paint / wallpaper finish
- L/360
 - Brittle finish (stone tiles or mosaic)
 - Higher level of finish required
- L/480
 - Eccentric (shelf loads)

For all other design pressure or limiting deflection criteria questions, please contact the Mada Technical Team.

3.3.2 - Head Clearance / Deflection Heads

Virtually every structure will experience deflection during its lifetime. Designers must consider potential live, dead, and other loadings on non-loadbearing walls since they are not designed to take on axial loading deflection.

The included standard head details should accommodate most service deflection requirements. Please contact the Mada Technical Team for further deflection head design assistance.

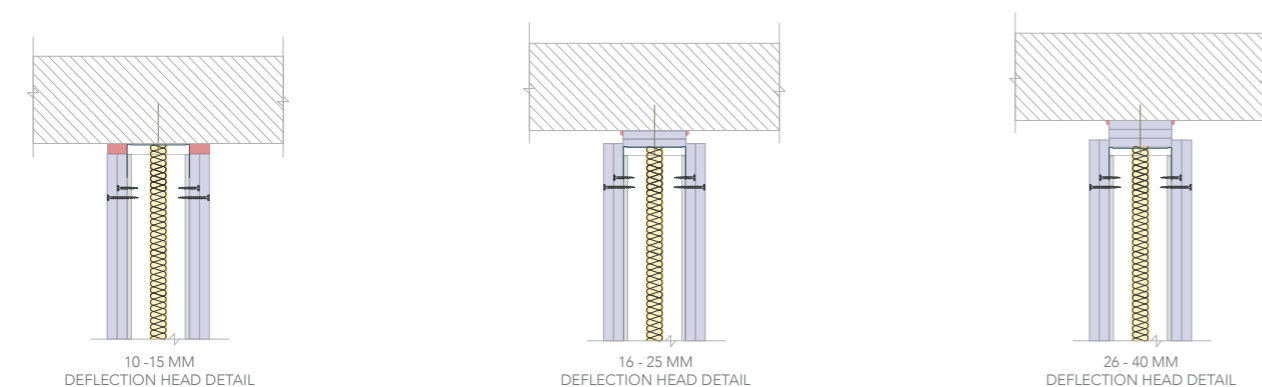

3.3.3 - Movement

Where linings and other wall and ceiling assemblies cross a structural movement joint, they will require a matching movement joint. Contact the Mada Technical Team for assistance with expansion joint options to meet your specific needs.



For more information, please consult the Mada System guide.

3.4 Service Integration

The following information is intended to support project detailing. Please note:

- All loadings are offered as Safe Working Loads (SWL) calculated using a safety factor of 4 (for steel fixings) or 7 (for plastic fixings) against the Typical Failure Load (TFL).
- Maximum heights of frames are explained in the Structure section
- Maximum height calculations do not include loadings
- For full calculations combining heights and loadings, please contact the Mada Technical team.
- Acoustic and fire performances can be affected by details

3.4.1 - Fixtures Direct to Board

Component Recommended	Fixing Method	Load Capacity
	Wall Mate screw suitable for use with MADA gypsum board	5 kg
	Fisher Butterfly fixing into single layer MADA gypsum board	20 kg Shear Load

3.4.2 - Fixing to Internal Framework

Based on safety factor of 4 (steel fixings) and 7 (plastic fixings) has been used

Description (per fixing)	SWL	TFL
Mada drywall plasterboard screws through Mada 0.7mm thick metal framing (stud/ fixing channel)	19 Kg	76 Kg
Mada drywall plasterboard screws through Mada 0.9mm thick metal framing (stud/ fixing channel)	30 Kg	120 Kg
Mada self tapping screws fixed through Mada 0.9mm metal framing	50 Kg	200 Kg
Steel expanding metal cavity fixing m6 x 40 through Mada plasterboard into 0.9mm thick Mada metal frame	40 Kg	160 Kg
Steel expanding metal cavity fixing m6 x 65 through Mada plasterboard into 0.9mm thick Mada metal frame (board thickness 12.5mm to 25)	50 Kg	200 Kg

*SWL: Safe working load

**TFL: Typical failure load

3.4.3 - Typical system detail

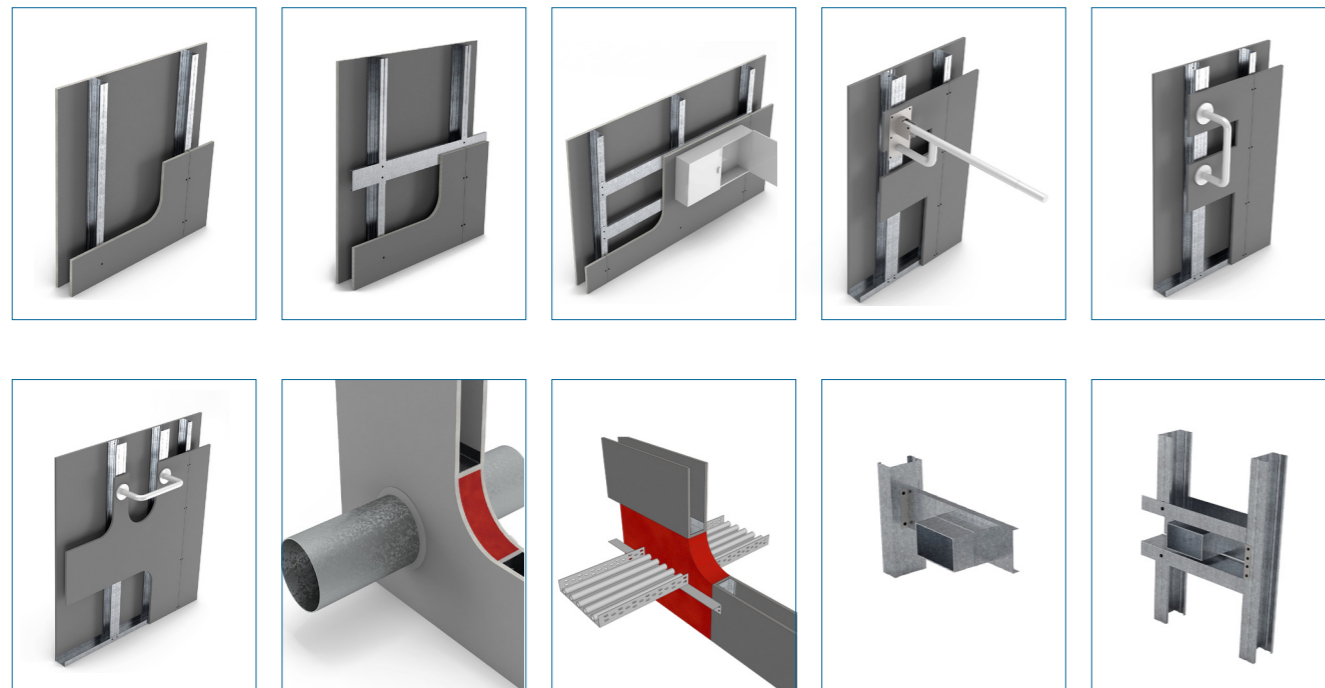

See project specification for exact requirements

Sector Focus

4

4.1

Robustness

The Building Regulations do not specifically detail requirements for the strength and robustness of partitions. However, BS 5234: Part 2: 1992 sets out structural performance requirements by room as per the below table:

BS5234: Part 2: 1992 Partition		
Duty	Category	Examples
Light	Adjacent space only accessible to persons with high incentive to exercise care. Small chance of accident occurring or of misuse	Staff accommodation
Medium	Adjacent space moderately used, primarily by persons with some incentive to exercise care. Some chance of accident occurring or of misuse	Teachers' office
Heavy	Adjacent space frequently used by the public and others with little incentive to exercise care. Chances of accident occurring or of misuse	Ancillary circulation areas
Severe	Adjacent space intensively used by the public and others with little incentive to exercise care. Prone to vandalism and abnormal rough use	Major circulation areas

Source: BS 5234: Part 2: 1992

4.2

Visual Aesthetics

In contrast to the European standard, which is excellent for understanding the level of robustness a partition can endure without failing, and consequently, which full constructions are fit-for-purpose, the ASTM C1629 Standard Classification for Abuse-Resistant Nondecorated Interior Gypsum Panel Products and Fiber-Reinforced Cement Panels assesses products and includes testing on the levels of Surface Abrasion Resistance and Indentation Resistance.

These subtle differences generate a focus on two linked elements of robustness:

- The ability of a construction to withstand differing types and levels of impact
- The appearance of a surface after testing. This means that only by considering both elements will a designer maximize maintenance cycles, minimize disruption, and ensure the visual appeal of the building is retained.

MGC has developed the Mada Plus Impact Resistant board specifically to comply with ASTM C1629. When a 16mm Mada Plus Impact Resistant board is constructed on either side of a Mada framework it will also achieve a Severe Duty rating of BS 5234.

4.3 Speech Clarity

Speech clarity refers to how well the listeners can understand the speaker. It might be challenging to hear speech in a reverberant space with distracting background noise.

The term "direct sound" refers to the sound that reaches the listener first. Then come the first reflections. Speech clarity benefits from the early reflections' integration with the direct sound, which reaches the listener within 50 ms. The reflections that follow might be considered disturbing.

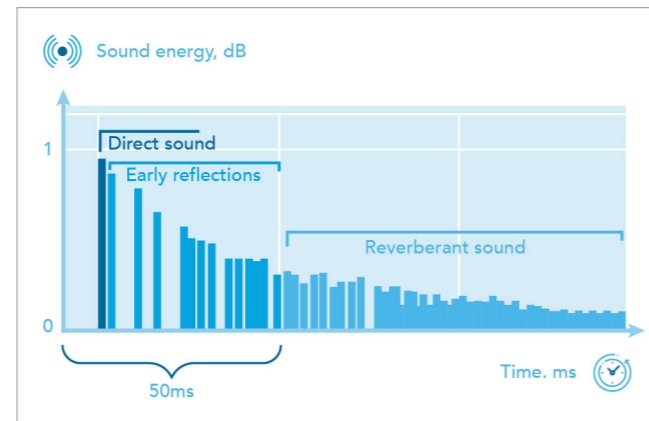
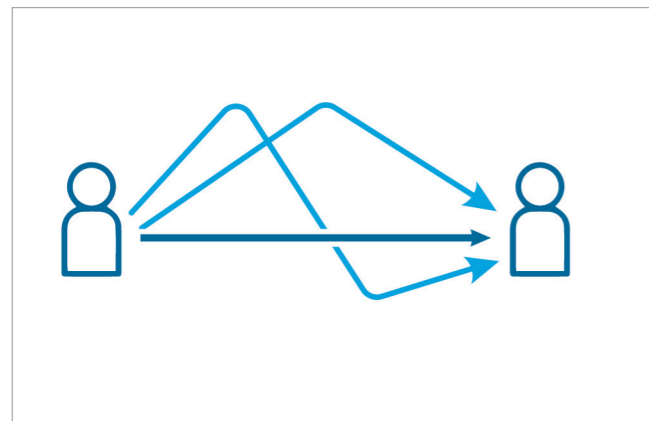

Bad speech transmission

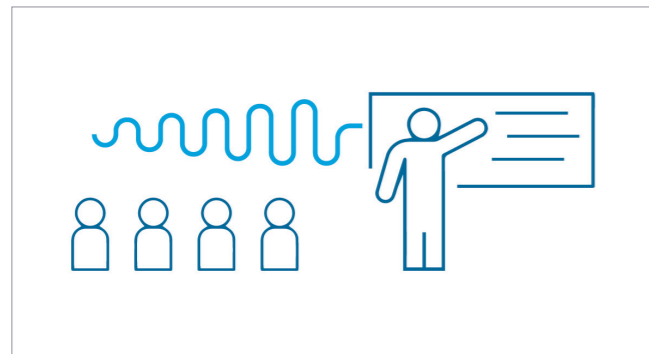

Good speech transmission

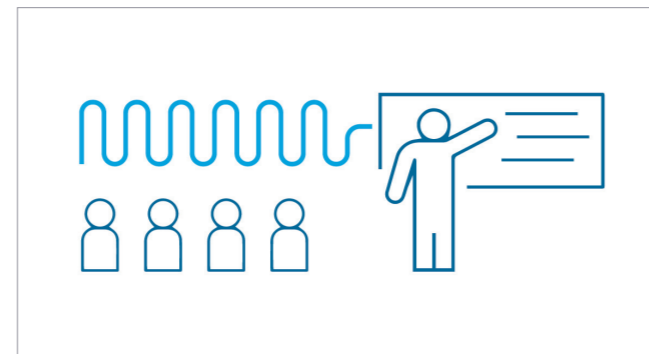

AMBIENT OR BACKGROUND NOISE LEVEL

Is the totality of all sounds within the room when the room is unoccupied

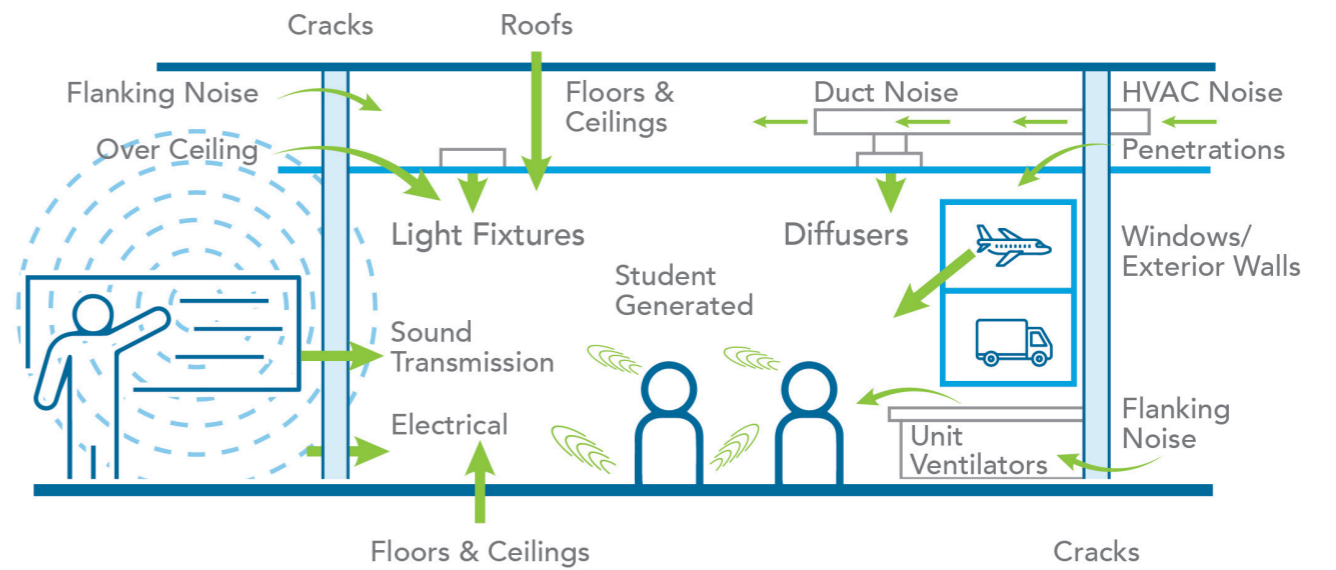

Background Noise Sources:

- Through walls from adjacent classrooms.
- Over the ceiling from adjacent classrooms.
- Through doors, around the frame and under the door.
- Through ventilators or louvers above door units.
- Through HVAC ductwork from adjacent rooms.
- HVAC noise from ceiling diffusers.
- Through the light fixtures.
- From outside, through exterior walls and windows.
- From the floor above.

To obtain a good signal-to-noise ratio in the classroom, it is crucial to identify and evaluate noise levels. The examination of space to see if it is appropriate for the use of Sound Field Amplification equipment is also crucial.

4.3.1 - Reverberation and Reverberation Time

Reverberation is primarily dependent on only two things:

- The volume of the space
- The amount of absorption in the space.

As in the case of a large, hard-surfaced gymnasium, the RT is much longer.

Even though some room reverberation can help with voice dispersion, prolonged reverberation periods can lead to a buildup of noise and deteriorate speech clarity.

The Sabine Formula for calculating the RT in a space is a simple mathematical formula presented as:

$$T = 0.049 \frac{V}{S}$$

where T is the reverberation time in seconds, 0.049 is a constant, V is the volume of the space, S is the surface area of all the surfaces and a is the absorption coefficient of the building material at a given frequency.

It is the designer or architect's responsibility to ensure that space meets the required reverberation times by providing the appropriate number of absorptive materials.

Mada recommends assigning a specialized acoustician for spaces where the acoustics requirements are stringent.

4.3.2 - Sound Transmission Class

The amount of airborne sound blocked from transmitting through a partition is measured in a Sound Transmission Class (STC) rating. A higher STC rating will Sound transmission through walls will add to the background noise level in the space, degrading the ability to hear and understand speech.

Single or composite walls, floor-ceiling, and roof-ceiling assemblies should provide specific sound transmission class (STC) ratings when separating a core learning space from an adjacent space. The table below provides preliminary STC values as per the recommendations of the Acoustical Society of America.

Area	STC Recommendation
If the adjacent space is a corridor, staircase, office, or conference room	45
If the adjacent space is another core learning space, speech clinic, health care room or outdoors	50
If the adjacent space is a restroom	53
If the adjacent space is a music room, mechanical equipment room, cafeteria, gymnasium, or indoor swimming pool.	60
Assemblies separating ancillary spaces from adjacent spaces	60
Classroom doors	30
Music room doors	40

Note: Open-plan classroom designs will not meet the requirements of this standard.

The materials and installation techniques utilized have a significant impact on the STC rating. To achieve a desired STC rating, wall and ceiling assemblies can be defined and detailed. The architect or designer is in charge of this. However, more will be needed than just stating an STC level. It is significant to note that sound leakage through penetrations, joints, and over or around the structure can have a significant impact on sound transmission.

The design should consider the quantity and placement of wall penetrations as well as the quantity and location of electrical outlets. Installation techniques become essential for meeting a defined STC. To reduce sound transfer between rooms, the electrical system placement and installation instructions are provided in Section 5.6. Electrical boxes shouldn't be placed in the same stud space as studs on single-stud walls. Boxes should be at least 600mm apart for walls with staggered or dual studs. If it is impossible to avoid them, back-to-back electrical boxes should be encased in complete gypsum board enclosures that do not touch the framing of the adjacent row of studs. Additionally, caulking or acoustical sealant should be used to completely seal off any connections and air gaps.

As was previously said, background noise is a major issue in learning environments. STC ratings will aid in reducing background noise levels in a location (depending on the effect of sound transmission on the background noise level). To satisfy a particular background noise level requirement, it can be necessary to raise a needed STC rating. Good site selection and space planning can prevent or decrease sound transmission issues.

Recommended STC performance data for walls and floors between classrooms and other spaces are listed in the new ANSI S-12.60-2002 Classroom Acoustics standard.

4.3.3 - Impact Insulation Class

A floor-ceiling assembly's capacity to prevent impact/structure-borne noise from transferring to the area below is measured by its Impact Insulation Class (IIC). A floor-ceiling assembly with a low IIC rating may generate distracting noise in the space below, which might result in aggravation and communication issues.

- Floor-ceiling assemblies above core learning spaces should have IIC ratings of at least IIC-45 and ideally IIC-50 (measured without carpeting on the floor).
- Core learning areas cannot be placed over gymnasiums, dance studios, or other high-floor-impact activities in new construction.
- If gymnasiums, dance studios, or other high-floor impact activities are situated above key learning areas in existing facilities, IIC-65-70 (depending on the capacity of the space below) is advised.

IIC is a significant issue for educational buildings with several stories. The floor-ceiling system needs to be designed and built to achieve the required IIC rating. Carpeting the floor above will assist to lessen the impact of noise. It can be essential to separate the ceiling from the floor above or the completed floor from the structural level. Rubber pads or spring systems need to be provided for any vibrating equipment that is mounted on the structure of the roof or above the floor. As with all other criteria in the standard, it is up to the architect or designers to specify and build accordingly, although careful construction and installation will be needed to guarantee compliance.

4.3.4 - Other Considerations

While typical classrooms may be the main concern there are many very noisy spaces in schools. Gymnasiums are notorious for being noisy as are many lunchrooms, swimming pools, industrial arts rooms, and band rooms.

The sound level of a Phys-Ed instructor's whistle in a reverberating gymnasium can be 130 decibels in his/her ear canal. Clearly, this is too loud and can lead to noise-induced hearing loss.

Band practice rooms can also be noisy with sound levels reaching more than 100 decibels and band directors who take no precautions can also sustain the noise-induced hearing loss.

4.4 Versatility

The previous few decades have seen significant advancements in classroom design. The traditional image of classrooms as strict, regimented settings for teacher-centered learning is drastically changing. Instead, for the benefit of both students and instructors, schools are embracing technology and more adaptable learning strategies. How can you help your pupils benefit from this trend?

4.4.1 - Adaptable spaces

The design of classrooms in schools is oriented toward fostering 21st-century learning. The adaptability of today's classroom layout is essential. The numerous facets of constructive learning are supported by the capacity to rearrange components.

Learners can actively undertake experiments because to versatility. to carry out problem-solving in the actual world. and to establish groups to analyze information jointly. In the meanwhile, teachers support and direct learning-enhancing activities for pupils.

Many innovative layouts are used in 21st century classroom designs, including:

- Flexible seating
- The modular classroom
- Classroom cribs
- Next-generation classroom design
- Evidence-based learning environments
- Learner-centered spaces
- Active learning environments

4.4.2 - Factors Affecting Students' Performance

A detailed study made in July 2015 of 153 classrooms in 27 schools (<https://doi.org/10.1016/j.buildenv.2015.02.013>) revealed that 73% of student performance is affected by:

Classroom Design Factors

- **Color:** Using color on walls, floors, and furniture will provide the classroom with ample visual stimulation.
- **Choice:** Quality furniture options include fascinating and comfortable tables and chairs. An ownership sensation should be supported by the furniture.
- **Complexity:** Providing interesting surroundings and eye-catching décor while maintaining order
- **Flexibility:** A classroom's capacity to accommodate pupils while avoiding overcrowding. the capacity to alter furniture for different activities and instructional methods.
- **Light:** The amount, quality, and degree of control over the illumination level.

Physical Classroom Features (NSI elements):

- **Naturalness:** About 50% of the influence on learning may be attributed to this area. It concerns the requirements for bodily comfort. These consist of „connections to nature,“ as well as light, sound, temperature, and air quality.
- **Stimulation:** This category describes the classroom's energy. It explains roughly 25% of learning differences.
- **Individuality:** For the remaining 25% of learning disparities, this group is responsible. Individuality includes how effectively a classroom satisfies students' needs by providing:
 - **Ownership:** How distinctive and customized the space is.
 - **Flexibility:** How effectively a space caters to a particular age group's demand and the use of various instructional techniques
 - **Connection:** A measure of how easily kids can connect with the rest of the school.

4.4.3 - Usable surfaces

Aside from design and aesthetics, partitions need to accommodate versatility and change, allowing different setups for shelves, pinboards, and other interactive elements. Such partitions need to be suitable for the fixation that ties to the service integration as stipulated in Mada System Guide.

Solution Selection

5

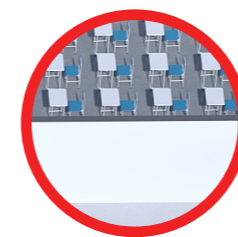

40 dB Range
Classroom to Corridor partition



45 dB Range
Music Room to Corridor partition

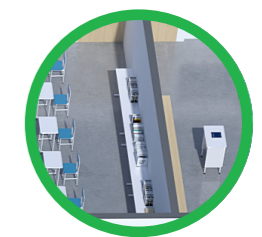

50 dB Range
Classroom to Classroom with
30m² dividing partition / 7dB
correction factor

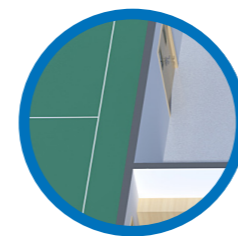

55 dB Range
Gymnasium to Changing Room
with 30m² dividing partition /
5dB correction factor



60 dB Range
Staff Room to Changing Room
with 12m² dividing partition /
5dB correction factor



65 dB Range
Classroom to a Music Room with
30m² dividing partition / 5dB
correction factor

5.1 Partitions

Teaching and studying can be disrupted by unwanted noise through the walls of adjacent spaces.

The new ANSI standards recommend that the background noise level in an unoccupied room should not be more than 35 dBA. That is about as quiet as an average living room with carpeted floors and no activity to speak of in the rest of the house. For most people 35 dBA is quiet. When we refer to dBA we are talking about the sound level in decibels (dB) in the A-weighted scale. The A weighting is a scale that resembles closely how our ears perceive sound, it discounts the low frequencies since our sense of hearing is less sensitive to low-frequency sounds.

On the other hand, BB93 provides more elaborate performance standards in terms of the level difference $D_{nT}(T_{mf, max})_w$ for the attenuation of airborne sound transmission between adjoining rooms. These values are defined by the activity in the source room and the noise tolerance in the receiving room. Basically, it considers two adjacent spaces and considers the

required sound quality in the rooms (for both volume and clarity), and then prescribes a requirement for each separating element (partition) onsite.

The calculation works in one direction only, so the level differences must be determined in both directions as one direction may have more stringent performance criteria. These values can simply be found in section 5.1.1 and traced across to where the two room types coincide.

The minimum weighted sound level difference between rooms is quoted in terms of $D_{nT}(T_{mf, max})_w$. However, partition performances are based on laboratory airborne sound insulation data measured in terms of sound reduction index R_w . BB93 also offers the method for converting from the onsite requirement to the manufacturer's R_w value.

The following procedure describes how to generate the requirement and then subsequently convert it to an R_w value. This can be used to select an appropriate partition specification.

01

Determine the minimum BB93 weighted standardized sound level difference between rooms in each direction and the associated reverberation time, $T_{mf, max}$ from the **matrix in section 5.1.1**.

02

Estimate the required weighted sound reduction index $R_{w est}$ using the following formula:

$$R_{w est} = D_{nT}(T_{mf, max})_w + \frac{10 \log (S \times T_{mf, max})}{V} + X \text{ dB}$$

(with X being from 5 to 7 dB)

Where: S = surface area of the separating element
V = volume of the receiving room

$T_{mf, max}$ = maximum value of the reverberation time T_{mf}

03

To account for less favorable mounting conditions and flanking noise transmission, a correction factor X is applied to the estimated value above. Mada Gypsum Company's recommendation is 5 dB, but a higher value may be required depending on the quality of flanking details – an acoustic consultant should be appointed to advise in this respect.

Therefore, the weighted sound reduction index R_w that should be used to select the partition from laboratory test data is:

$$R_w = R_{w est} + X \text{ dB or } R_w = R_{w est} + 5 \text{ dB}$$

It is not possible to calculate the acoustic requirement by room type without the precise room dimensions. To demonstrate the full calculation, an example based on a typical secondary school is shown later.



5.1.2 - Reverberation time (T_{mf})

Type	Room	T_{mf} (seconds)
Nursery school	Playrooms	≤0.6
	Quiet rooms	≤0.6
Primary school	Classrooms, class bases, general teaching areas, seminar rooms, tutorial rooms, language laboratories	≤0.6
Secondary school	Classrooms, general teaching areas, seminar rooms, tutorial rooms, language laboratories	≤0.8
Open plan	Teaching areas	≤0.8
	Resource areas	≤1.0
Music	Classrooms	≤1.0
	Small practice / group room	≤0.8
	Ensemble room	0.6 - 1.2
	Performance / recital room	1.0 - 1.5
	Recording studio	0.6 - 1.2
Lecture rooms	Control room for recording	≤0.5
	Small (fewer than 50 people)	≤0.8
	Large (more than 50 people)	≤1.0
Classrooms designed specifically for use by hearing impaired students (including speech therapy rooms)		≤0.4
Study room (individual study, withdrawal, remedial work, teacher preparation)		≤0.8
Libraries		
Science laboratories	Quiet study areas	≤1.0
	Resource areas	≤1.0
Drama studios		≤0.8
Design and		≤1.0
Technology	Resistant materials, CAD/CAM areas	≤0.8
	Electronics / control, textiles, food, graphics, design / resource areas	≤0.8
Art rooms		≤0.8
Assembly halls, multi-purpose halls (drama, PE, audio / visual presentations, assembly, occasional music)		0.8 - 1.2
Audio visual, video conference rooms		≤0.8
Atria, circulation spaces used by students		≤1.5
Indoor sports hall		≤1.5
Dance studio		≤1.2
Gymnasium		≤1.5
Swimming pool		≤2.0
Interviewing / counselling rooms, medical rooms		≤0.8
Dining rooms		≤1.0
Ancillary spaces	Kitchens	≤1.5
	Offices, staff rooms	≤1.0
	Corridors, stairwells	-
	Coats and changing areas	≤1.5
	Toilets	≤1.5

5.1.3 - Partition System References by Range

40 dB Range



Detail MON 1
No insulation

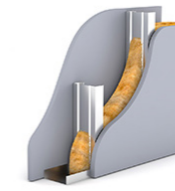

Detail MON 2
25 mm of Mada Glasswool insulation (16kg/m³)

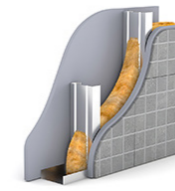

Detail AQU 2
25mm of Mada Glasswool insulation (16Kg/m³)

System Ref.	Width (mm)	Stud (mm)	Section Detail	Board Configuration per Side	STC	Max. H (mm) / 0.24kPa	R _w (dB)	Max. H (mm) / 0.20kPa
30 Min Fire Rating								
MON112*	75	48x0.55	MON 2	1 x 12.5 Fire Resistant	37	2800	40	3050
MON103*	75	48x0.55	MON 1	1 x 12.5 Impact Resistant	37	2800	40	3050
MON205*	102	68x0.55	MON 1	1 x 16 Regular	40	3850	40	4200
MON203*	95	68x0.55	MON 1	1 x 12.5 Impact Resistant	41	3700	41	4050
MON305*	132	98x0.55	MON 1	1 x 16 Regular	41	4900	41	5350
MON111*	75	48x0.55	MON 2	1 x 12.5 Regular	40	2800	42	3050
MON211*	95	68x0.55	MON 2	1 x 12.5 Regular	40	3700	42	4050
MON311*	125	98x0.55	MON 2	1 x 12.5 Regular	40	4600	42	5050
MON411*	175	148x0.80	MON 2	1 x 12.5 Regular	40	6800	42	7300
MON402*	175	148x0.80	MON 1	1 x 12.5 Fire Resistant	41	6800	42	7300
MON303*	125	98x0.55	MON 1	1 x 12.5 Impact Resistant	45	4600	43	5050
MON405*	182	148x0.80	MON 1	1 x 16 Regular	41	6950	43	7450
MON312*	125	98x0.55	MON 2	1 x 12.5 Fire Resistant	44	4600	44	5050
AQU1144	75	48x0.55	AQU 2	1 x 12.5 ProGuard	39	2800	41	3050
60 Min Fire Rating								
MON106	82	48x0.55	MON 1	1 x 16 Fire Resistant	42	2950	41	3200
MON206	102	68x0.55	MON 1	1 x 16 Fire Resistant	41	3850	41	4200
MON306	132	98x0.55	MON 1	1 x 16 Fire Resistant	41	4900	41	5350
MON406	182	148x0.80	MON 1	1 x 16 Fire Resistant	41	6950	41	7450
MON207	102	68x0.55	MON 1	1 x 16 Impact Resistant	45	3850	43	4200
AQU1188	82	48x0.55	AQU 2	1 x 16 ProGuard	40	2950	41	3200

Range minimized to aid selection. For other stud specifications and height requirements, please consult the system guide and contact Mada Technical Team.

* System not suitable for severe duty

45 dB Range



Detail MON 1
No insulation

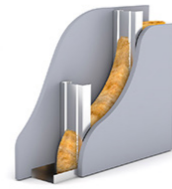

Detail MON 2
25 mm of Mada Glasswool insulation (16kg/m³)



Detail MUL 1
No Insulation

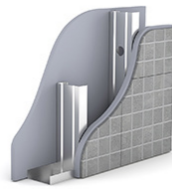

Detail AQU 1
No insulation

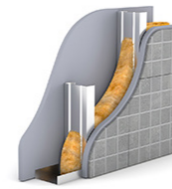

Detail AQU 2
25mm of Mada Glasswool insulation 16Kg/m³

System Ref.	Width (mm)	Stud (mm)	Section Detail	Board Configuration per Side	STC	Max. H (mm) / 0.24kPa	R _w (dB)	Max. H (mm) / 0.20kPa
30 Min Fire Rating								
MON213*	95	68x0.55	MON 2	1 x 12.5 Impact Resistant	46	3700	46	4050
MON403*	175	148x0.80	MON 1	1 x 12.5 Impact Resistant	46	6800	46	7300
MON315*	132	98x0.55	MON 2	1 x 16 Regular	48	4900	47	5350
MON412*	175	148x0.80	MON 2	1 x 12.5 Fire Resistant	48	6800	47	7300
MON313*	125	98x0.55	MON 2	1 x 12.5 Impact Resistant	50	4900	49	5350
MON415*	182	148x0.80	MON 2	1 x 16 Regular	48	6950	49	7450
AQU1099	75	48x0.55	AQU 1	1 x 12.5 Procem	46	2500	46	2750
AQU1192**	75	48x0.55	AQU 2	1 x 12.5 Procem	49	2500	48	2750
60 Min Fire Rating								
MON307	132	98x0.55	MON 1	1 x 16 Impact Resistant	46	4900	45	5350
MON407	182	148x0.80	MON 1	1 x 16 Impact Resistant	46	6950	47	7450
MON217	102	68x0.55	MON 2	1 x 16 Impact Resistant	50	3850	48	4200
MUL101	100	48x0.55	MUL 1	2 x 12.5 Regular	50	3100	49	3600
MUL201	120	68x0.55	MUL 1	2 x 12.5 Regular	50	4100	49	4800
MUL301	150	98x0.55	MUL 1	2 x 12.5 Regular	50	5100	49	6000
MUL401	200	148x0.80	MUL 1	2 x 12.5 Regular	50	7300	49	8300

Range minimized to aid selection. For other stud specifications and height requirements, please consult the system guide and contact Mada Technical Team.

* System not suitable for severe duty

** Asymmetrical solution - other side is 12.5 Fire Resistant

50 dB Range

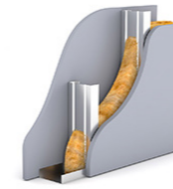

Detail MON 2
25 mm of Mada Glasswool insulation (16kg/m³)



Detail MUL 1
No Insulation

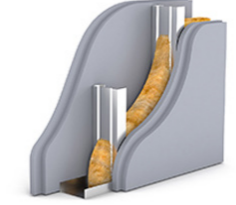

Detail MUL 2
25mm of Mada Glasswool insulation (16kg/m³)

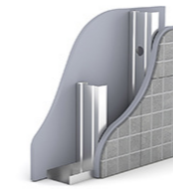

Detail AQU 1
No insulation

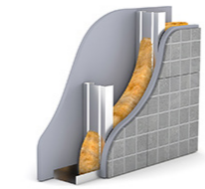

Detail AQU 2
25mm of Mada Glasswool insulation 16Kg/m³

System Ref.	Width (mm)	Stud (mm)	Section Detail	Board Configuration per Side	STC	Max. H (mm) / 0.24kPa	R _w (dB)	Max. H (mm) / 0.20kPa
30 Min Fire Rating								
MON413*	175	148x0.80	MON 2	1 x 12.5 Impact Resistant	51	6800	51	7300
60 Min Fire Rating								
MON317	132	98x0.55	MON 2	1 x 16 Impact Resistant	51	4900	50	5350
MON417	182	148x0.80	MON 2	1 x 16 Impact Resistant	51	6950	52	7450
MUL405	214	148x0.80	MUL 1	2 x 16 Regular	53	7350	52	8350
MUL111	100	48x0.55	MUL 2	2 x 12.5 Regular	54	3100	54	3600
MUL211	120	68x0.55	MUL 2	2 x 12.5 Regular	54	4100	54	4800
MUL311	150	98x0.55	MUL 2	2 x 12.5 Regular	54	5100	54	6000
MUL411	200	148x0.80	MUL 2	2 x 12.5 Regular	54	7300	54	8300
AQU11PP	80	48x0.55	AQU 2	1 x 15 Procem	52	2650	51	2900
120 Min Fire Rating								
MUL102	100	48x0.55	MUL 1	2 x 12.5 Fire Resistant	52	3100	51	3600
MUL202	120	68x0.55	MUL 1	2 x 12.5 Fire Resistant	52	4100	51	4800
MUL302	150	98x0.55	MUL 1	2 x 12.5 Fire Resistant	52	5100	51	6000
MUL402	200	148x0.80	MUL 1	2 x 12.5 Fire Resistant	52	7300	51	8300
MUL105	114	48x0.55	MUL 1	2 x 16 Regular	53	3150	52	3650
MUL205	136	68x0.55	MUL 1	2 x 16 Regular	53	4150	52	4850
MUL305	166	98x0.55	MUL 1	2 x 16 Regular	53	5300	52	6200
AQU10444	100	48x0.55	AQU 1	2 x 12.5 ProGuard	50	3100	51	3600

Range minimized to aid selection. For other stud specifications and height requirements, please consult the system guide and contact Mada Technical Team.

* System not suitable for severe duty

55 dB Range



Detail MUL 1
No Insulation

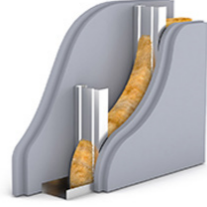

Detail MUL 2
25mm of Mada Glasswool insulation (16kg/m³)



Detail FIR 1
No Insulation

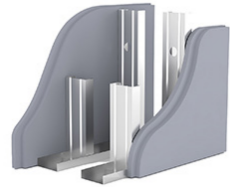

Detail SOU 1
No insulation

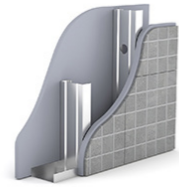

Detail AQU 1
No insulation

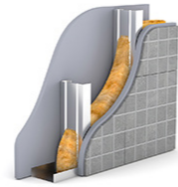

Detail AQU 2
25mm of Mada Glasswool insulation (16kg/m³)

System Ref.	Width (mm)	Stud (mm)	Section Detail	Board Configuration per Side	STC	Max. H (mm) / 0.24kPa	R _w (dB)	Max. H (mm) / 0.20kPa
60 Min Fire Rating								
MUL415	214	148x0.80	MUL 2	2 x 16 Regular	57	7350	57	8350
FIR101	125	48x0.55	FIR 1	3 x 12.5 Regular	56	3150	55	3650
FIR201	147	68x0.55	FIR 1	3 x 12.5 Regular	56	4150	55	4850
FIR301	177	98x0.55	FIR 1	3 x 12.5 Regular	56	5300	55	6200
FIR401	225	148x0.80	FIR 1	3 x 12.5 Regular	56	7350	55	8350
SOU105	160	48x0.55	SOU 1	2 x 16 Regular	54	2200	55	2450
SOU205	204	68x0.55	SOU 1	2 x 16 Regular	54	2500	55	2850
SOU305	264	98x0.55	SOU 1	2 x 16 Regular	54	3700	55	4150
SOU405	360	148x0.80	SOU 1	2 x 16 Regular	54	6100	55	6600
AQU109999	100	48x0.55	AQU 1	2 x 12.5 Procem	58	2800	57	3300
120 Min Fire Rating								
MUL203	120	68x0.55	MUL 1	2 x 12.5 Impact Resistant	56	4100	55	4800
MUL303	150	98x0.55	MUL 1	2 x 12.5 Impact Resistant	56	5100	55	6000
MUL403	200	148x0.80	MUL 1	2 x 12.5 Impact Resistant	56	7300	55	8300
MUL112	100	48x0.55	MUL 2	2 x 12.5 Fire Resistant	56	3100	56	3600
MUL107	114	48x0.55	MUL 1	2 x 16 Impact Resistant	55	3150	56	3650
MUL212	120	68x0.55	MUL 2	2 x 12.5 Fire Resistant	56	4100	56	4800
MUL207	136	68x0.55	MUL 1	2 x 16 Impact Resistant	55	4150	56	4850
MUL312	150	98x0.55	MUL 2	2 x 12.5 Fire Resistant	56	5100	56	6000
MUL412	200	148x0.80	MUL 2	2 x 12.5 Fire Resistant	56	7300	56	8300
MUL115	114	48x0.55	MUL 2	2 x 16 Regular	57	3150	57	3650
MUL215	136	68x0.55	MUL 2	2 x 16 Regular	57	4150	57	4850
MUL315	166	98x0.55	MUL 2	2 x 16 Regular	57	5300	57	6200
MUL213	120	68x0.55	MUL 2	2 x 12.5 Impact Resistant	58	4100	59	4850
MUL313	150	98x0.55	MUL 2	2 x 12.5 Impact Resistant	58	5100	59	6000
MUL413	200	148x0.80	MUL 2	2 x 12.5 Impact Resistant	58	7300	59	8350
AQU114444	100	48x0.55	AQU 2	2 x 12.5 ProGuard	56	3100	56	3600
180 Min Fire Rating								
MUL415	125	48x0.55	FIR 1	3 x 12.5 Fire Resistant	58	3150	57	3650
FIR101	147	68x0.55	FIR 1	3 x 12.5 Fire Resistant	58	4150	57	4850
FIR201	177	98x0.55	FIR 1	3 x 12.5 Fire Resistant	58	5300	57	6200
FIR301	225	148x0.80	FIR 1	3 x 12.5 Fire Resistant	58	7350	57	8350

Range minimized to aid selection. For other stud specifications and height requirements, please consult the system guide and contact Mada Technical Team.

60 dB Range

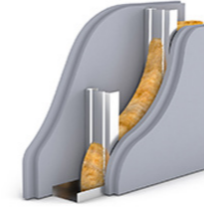

Detail MUL 2
25mm of Mada Glasswool insulation (16kg/m³)

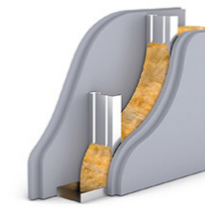

Detail MUL 3
50mm of Mada Glasswool insulation (16kg/m³)

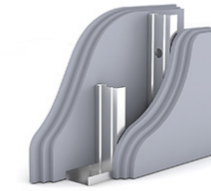

Detail FIR 1
No Insulation



Detail FIR 2
25mm of Mada Glasswool insulation (16kg/m³)

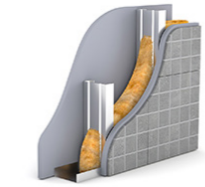

Detail AQU 2
25mm of Mada Glasswool insulation (16kg/m³)

System Ref.	Width (mm)	Stud (mm)	Section Detail	Board Configuration per Side	STC	Max. H (mm) / 0.24kPa	R _w (dB)	Max. H (mm) / 0.20kPa
90 Min Fire Rating								
FIR111	125	48x0.55	FIR 2	3 x 12.5 Regular	59	3150	60	3650
FIR211	147	68x0.55	FIR 2	3 x 12.5 Regular	59	4150	60	4850
FIR311	177	98x0.55	FIR 2	3 x 12.5 Regular	59	5300	60	6200
FIR411	225	148x0.80	FIR 2	3 x 12.5 Regular	59	7350	60	8350
AQU119999	100	48x0.55	AQU 2	2 x 12.5 Procem	61	2800	60	3300
AQU319999	150	98x0.55	AQU 2	2 x 12.5 Procem	61	4800	60	5700
120 Min Fire Rating								
MUL117	114	48x0.55	MUL 2	2 x 16 Impact Resistant	57	3150	60	3650
MUL217	136	68x0.55	MUL 2	2 x 16 Impact Resistant	57	4150	60	4850
MUL323	150	98x0.55	MUL 3	2 x 12.5 Impact Resistant	58	5100	60	6000
MUL317	166	98x0.55	MUL 2	2 x 16 Impact Resistant	57	5300	60	6200
FIR112	125	48x0.55	FIR 2	3 x 12.5 Fire Resistant	61	3150	61	3650
FIR103	125	48x0.55	FIR 1	3 x 12.5 Impact Resistant	61	3150	61	3650
FIR212	147	68x0.55	FIR 2	3 x 12.5 Fire Resistant	61	4150	61	4850
FIR203	147	68x0.55	FIR 1	3 x 12.5 Impact Resistant	61	4150	61	4850
FIR312	177	98x0.55	FIR 2	3 x 12.5 Fire Resistant	61	5300	61	6200
FIR303	177	98x0.55	FIR 1	3 x 12.5 Impact Resistant	61	5300	61	6200
FIR412	225	148x0.80	FIR 2	3 x 12.5 Fire Resistant	61	7350	61	8350
FIR403	225	148x0.80	FIR 1	3 x 12.5 Impact Resistant	61	7350	61	8350
180 Min Fire Rating								
FIR107	146	48x0.55	FIR 1	3 x 16 Impact Resistant	60	3150	61	3650
FIR207	168	68x0.55	FIR 1	3 x 16 Impact Resistant	60	4150	61	4850
FIR307	198	98x0.55	FIR 1	3 x 16 Impact Resistant	60	5300	61	6200
FIR407	246	148x0.80	FIR 1	3 x 16 Impact Resistant	60	7350	61	8350

Range minimized to aid selection. For other stud specifications and height requirements, please consult the system guide and contact Mada Technical Team.

5.2 Shaftwall Solutions

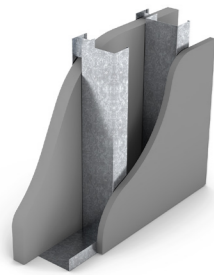

Detail SHA 1
No insulation

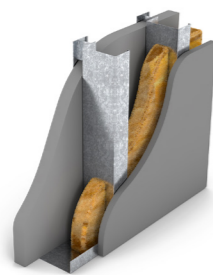

Detail SHA 2
25 mm of Mada Glasswool insulation (16kg/m³)

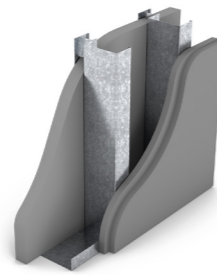

Detail SHA 3
No insulation

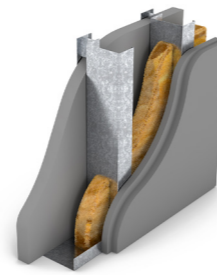

Detail SHA 4
25 mm of Mada Glasswool insulation (16kg/m³)

System Ref.	Width (mm)	Stud (mm)	Section Detail	25mm Shaft Board side A + Board Configuration Side B	Insulation Thickness (mm)	STC	Max. H (mm) / 0.24kPa	R _w (dB)	Max. H (mm) / 0.20kPa
45 dB Range									
60 Min Fire Rating									
SHA10S6	82	64x0.60	SHA 1	1 Layer of 16 Fire Resistant	*	44	4000	43	4400
SHA30S6	118	100x0.60	SHA 1	1 Layer of 16 Fire Resistant	*	44	5500	43	6100
SHA50S6	168	150x0.60	SHA 1	1 Layer of 16 Fire Resistant	*	44	5500	43	6100
SHA10S7	82	64x0.60	SHA 1	1 Layer of 16 Impact Resistant	*	45	4000	45	4400
SHA30S7	118	100x0.60	SHA 1	1 Layer of 16 Impact Resistant	*	45	5500	45	6100
SHA50S7	168	150x0.60	SHA 1	1 Layer of 16 Impact Resistant	*	45	5500	45	6100
SHA11S6	82	64x0.60	SHA 2	1 Layer of 16 Fire Resistant	25	47	4000	46	4400
SHA31S6	118	100x0.60	SHA 2	1 Layer of 16 Fire Resistant	25	47	5500	46	6100
SHA51S6	168	150x0.60	SHA 2	1 Layer of 16 Fire Resistant	25	47	5500	46	6100
SHA11S7	82	64x0.60	SHA 2	1 Layer of 16 Impact Resistant	25	48	4000	47	4400
SHA31S7	118	100x0.60	SHA 2	1 Layer of 16 Impact Resistant	25	48	5500	47	6100
SHA51S7	168	150x0.60	SHA 2	1 Layer of 16 Impact Resistant	25	48	5500	47	6100
120 Min Fire Rating									
SHA10S66	98	64x0.60	SHA 3	2 Layers of 16 Fire Resistant	*	48	4000	48	4400
SHA30S66	134	100x0.60	SHA 3	2 Layers of 16 Fire Resistant	*	48	5500	48	6100
SHA50S66	184	150x0.60	SHA 3	2 Layers of 16 Fire Resistant	*	48	5500	48	6100
SHA10S67	98	64x0.60	SHA 3	1 Layer of 16 Fire & 16 Impact Resistant	*	49	4000	49	4400
SHA30S67	134	100x0.60	SHA 3	1 Layer of 16 Fire & 16 Impact Resistant	*	49	5500	49	6100
SHA50S67	184	150x0.60	SHA 3	1 Layer of 16 Fire & 16 Impact Resistant	*	49	5500	49	6100
50 dB Range									
60 Min Fire Rating									
SHA11S66	98	64x0.60	SHA 4	2 Layers of 16 Fire Resistant	25	50	4000	50	4400
SHA31S66	134	100x0.60	SHA 4	2 Layers of 16 Fire Resistant	25	50	5500	50	6100
SHA51S66	184	150x0.60	SHA 4	2 Layers of 16 Fire Resistant	25	50	5500	50	6100
SHA11S67	98	64x0.60	SHA 4	1 Layer of 16 Fire & 16 Impact Resistant	25	51	4000	51	4400
SHA31S67	134	100x0.60	SHA 4	1 Layer of 16 Fire & 16 Impact Resistant	25	51	5500	51	6100
SHA51S67	184	150x0.60	SHA 4	1 Layer of 16 Fire & 16 Impact Resistant	25	51	5500	51	6100

Range minimized to aid selection. For other stud specifications and height requirements, please consult the system guide and contact Mada Technical Team.

5.3 Wall Linings

5.3.1 - Dot & Dab

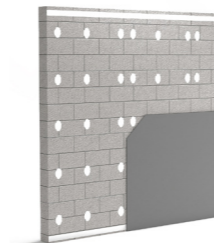

As one of the original systems for using adhesive for drylining masonry walls, the dot & dab system has been tried and tested in every sector and remains one of the narrowest solutions for creating a cavity for MEP whilst producing a consistently smooth finish.

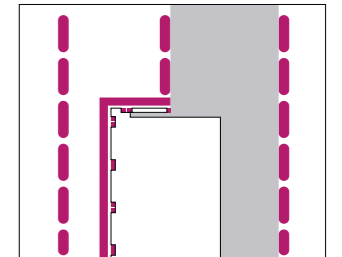
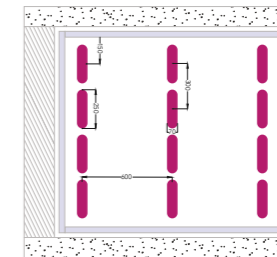

5.3.2 - Braced Liner

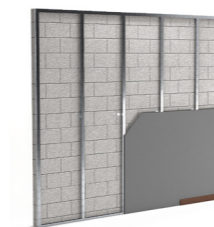

here the existing substrate is not suitable for a directly bonded solution, a frame is required to support the lining. This liner system braces to the background to allow for minimal width build-ups and allows for acoustic upgrades to the existing wall.

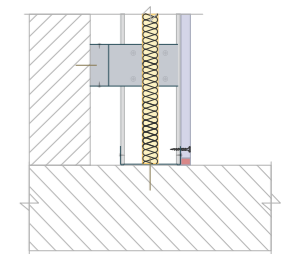
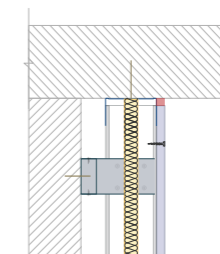

5.3.3 - Independent Liner

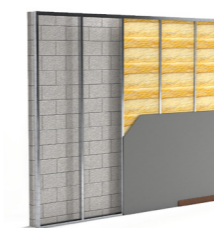

As one of the original systems for using adhesive for drylining masonry walls, the dot & dab system has been tried and tested in every sector and remains one of the narrowest solutions for creating a cavity for MEP whilst producing a consistently smooth finish.

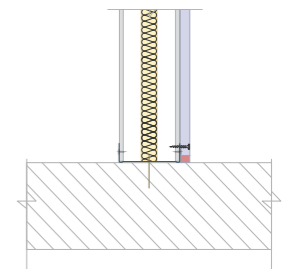
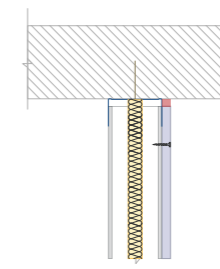

5.3.3 - Independent Liner (continued)

45 dB Range*

System Ref.	Width (mm)	Stud (mm)	Board Configuration on one side	STC	Max. H (mm) / 0.24kPa	R _w (dB)	Max. H (mm) / 0.20kPa
ILS101	62.5	48x0.50	1 x 12.5 Regular	47	2150	47	2400
ILS102	62.5	48x0.50	1 x 12.5 Fire Resistant	48	2150	47	2400

50 dB Range*

System Ref.	Width (mm)	Stud (mm)	Board Configuration on one side	STC	Max. H (mm) / 0.24kPa	R _w (dB)	Max. H (mm) / 0.20kPa
ILS201	82.5	68x0.50	1 x 12.5 Regular	50	2550	49	2800
ILS202	82.5	68x0.50	1 x 12.5 Fire Resistant	51	2550	50	2800
ILS301	112.5	98x0.50	1 x 12.5 Regular	52	4000	51	4250
ILS204	82.5	68x0.50	1 x 12.5 ProGuard	52	2550	51	2800
ILS205	86	68x0.50	1 x 16 Regular	52	2550	51	2800
ILS206	86	68x0.50	1 x 16 Fire Resistant	52	2550	51	2800
ILS305	116	98x0.50	1 x 16 Regular	53	4000	52	4250
ILS203	82.5	68x0.50	1 x 12.5 Impact Resistant	53	2550	52	2800
ILS209	82.5	68x0.50	1 x 12.5 Procem	53	2100	52	2350
ILS303	112.5	98x0.50	1 x 12.5 Impact Resistant	54	4000	53	4250
ILS304	112.5	98x0.50	1 x 12.5 ProGuard	53	4000	53	4250
ILS309	112.5	98x0.50	1 x 12.5 Procem	54	3700	53	3950
ILS201	95	68x0.50	2 x 12.5 Regular	54	2850	53	3100
ILS301	125	98x0.50	2 x 12.5 Regular	55	4300	54	4550

55 dB Range*

System Ref.	Width (mm)	Stud (mm)	Board Configuration on one side	STC	Max. H (mm) / 0.24kPa	R _w (dB)	Max. H (mm) / 0.20kPa
ILS211	82.5	68x0.50	1 x 12.5 Regular	56	2550	55	2800
ILS221	82.5	68x0.50	1 x 12.5 Regular	56	2550	55	2800
ILS203	95	68x0.50	2 x 12.5 Impact Resistant	55	2850	55	3100
ILS204	95	68x0.50	2 x 12.5 ProGuard	55	2850	55	3100
ILS311	112.5	98x0.50	1 x 12.5 Regular	57	4000	56	4250
ILS319	112.5	98x0.50	1 x 12.5 Procem	56	3700	56	3950
ILS304	125	98x0.50	2 x 12.5 ProGuard	56	4300	56	4550
ILS219	82.5	68x0.50	1 x 12.5 Procem	56	2100	56	2350
ILS314	112.5	98x0.50	1 x 12.5 ProGuard	57	4000	57	4250
ILS311	125	98x0.50	2 x 12.5 Regular	57	4300	57	4550
ILS214	82.5	68x0.50	1 x 12.5 ProGuard	57	2550	57	2800
ILS211	95	68x0.50	2 x 12.5 Regular	57	2850	57	3100

*Acoustic performance includes blockwork.

5.4 Monolithic Ceilings

5.4.1 - Metal Framing Ceiling

The most common solution for creating simple, cost-effective, monolithic ceilings, Mada Metal Framing Ceiling is highly adaptive being able to offer fire-rated solutions and high-performance acoustic mass barrier configurations.

5.4.1.1 - Angle Fixation

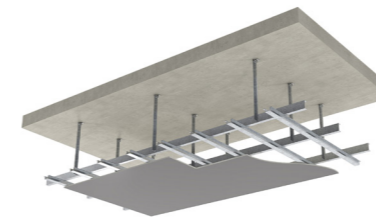

No Fire Rating

Board Thickness
Layers of 12.5 Mada Regular
Plasterboard

Main Channel Centers
900mm

Furring Channel Centers
400mm

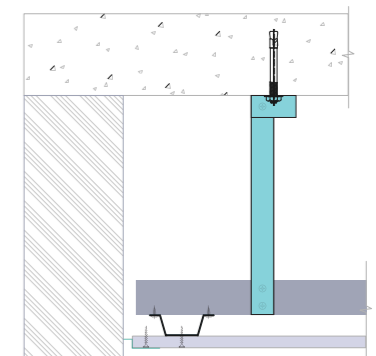

5.4.1.2 Threaded Rod Fixation

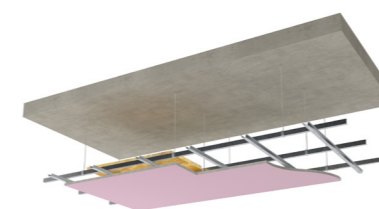

1 Hour Fire Rated Solution
Fire rating EN1364-2: 60 min

Board Thickness
2 Layers of 16 Fire Resistant

Insulation
50mm Rockwool (40kg/m³)

Main Channel Centers
900mm

Furring Channel Centers
400mm

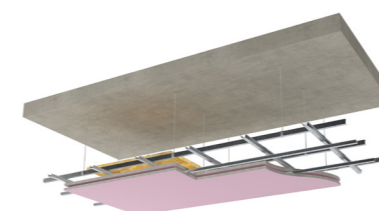
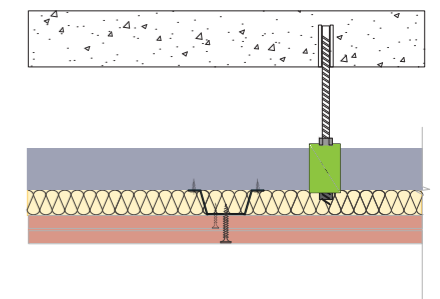

2 Hours Fire Rated Solution
Fire rating EN1364-2: 120 min

Board Thickness
4 Layers of 16 Fire Resistant

Insulation
50mm Rockwool (40kg/m³)

Main Channel Centers
900mm

Furring Channel Centers
400mm

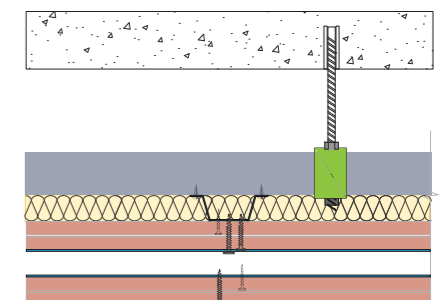

5.4.2 - Corridor Spanning System

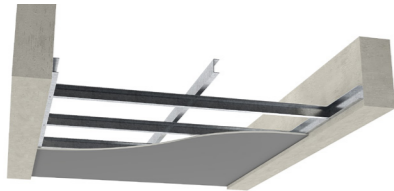

Horizontal Frame	Centres (mm)	Thickness (mm)	Span (mm)
			1 layer of 15mm board
48mm 'C' stud	400	0.55	1900
		0.9	2200
	300	0.55	2150
		0.9	2350
68mm 'C' stud	400	0.55	2400
		0.9	2700
	300	0.55	2950
		0.9	3400
98mm 'C' stud	400	0.55	3500
		0.9	3750
	300	0.55	3800
		0.9	4050
148mm 'C' stud	400	0.8	5050
		0.9	5350
	300	0.8	5300
		0.9	5800

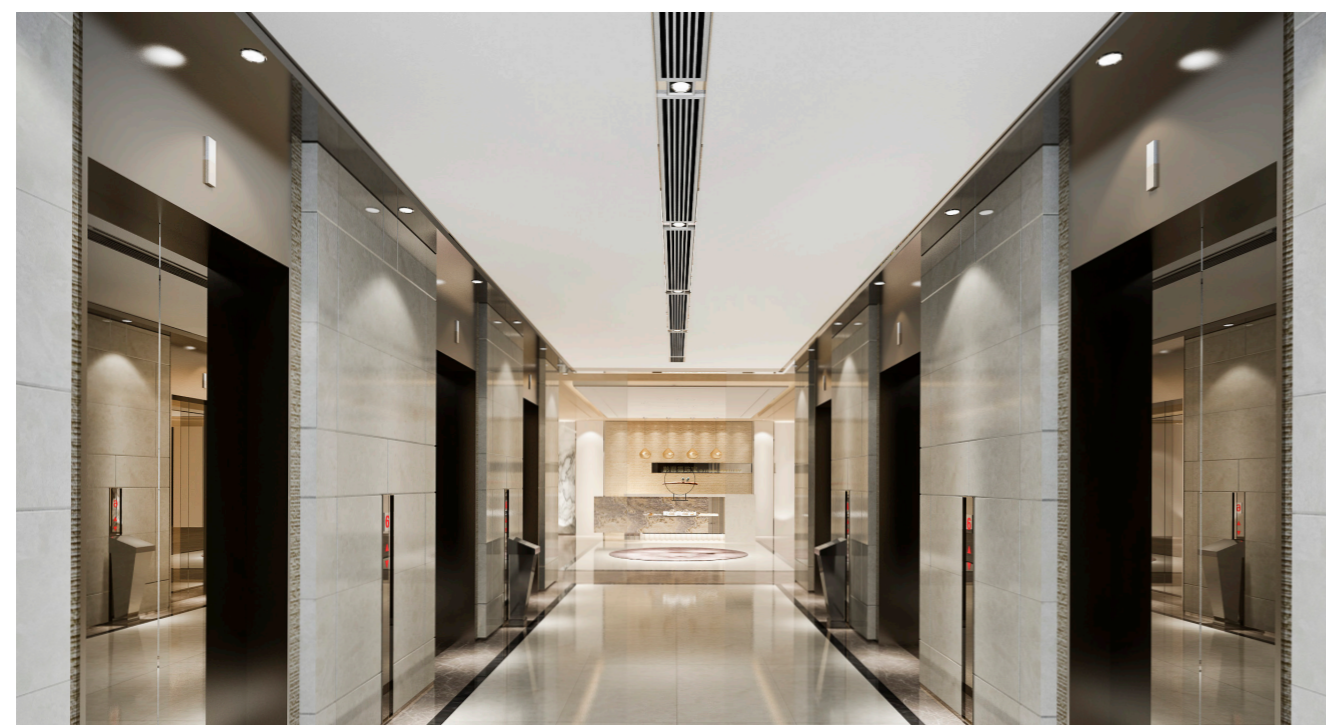

5.5 Exterior Envelop

Mada ProGuard glass mat sheathing is an ideal light-weight solution for exterior envelop, offering ease to install, moisture and mold resistance, Class A fire resistance, designed for use under Exterior Insulation Finish Systems (EIFS), exterior claddings like brick veneer, marble cladding, siding systems, porcelain tiling and conventional stucco or direct render.

Indicative Framing & Insulation	Fire Rating	Boarding	Finish Options			
			Direct Render		Insulated Render (IFS)	
			Thickness (mm)	U-value (W/m ² K)	Thickness (mm)	U-value (W/m ² K)
100mm Stud with 90mm infill (Density 50kg/m ³)	60 min	External: 1x16mm ProGuard Internal: 1x16mm Impact Resistant	132	0.345	182	0.229
	120min	External: 2x16mm Impact Resistant Internal: 1x12.5mm ProGuard	157		207	
125mm Stud with 100mm in fill (Density 50kg/m ³)	60 min	External: 1x16mm ProGuard Internal: 1x16mm Impact Resistant	157	0.315	207	0.215
	120min	External: 2x16mm Impact Resistant Internal: 1x16mm ProGuard	182		232	
150mm Stud with 120mm in fill (Density 50kg/m ³)	60 min	External: 1x16mm ProGuard Internal: 1x16mm Impact Resistant	182	0.268	232	0.192
	120min	External: 2x16mm Impact Resistant Internal: 1x12.5mm ProGuard	207		257	

Cladding

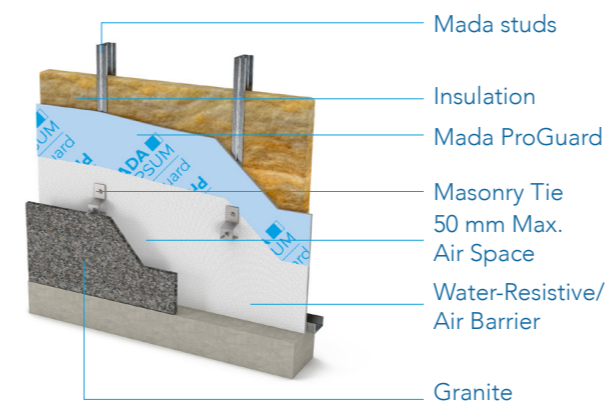

Stucco Direct Rendering

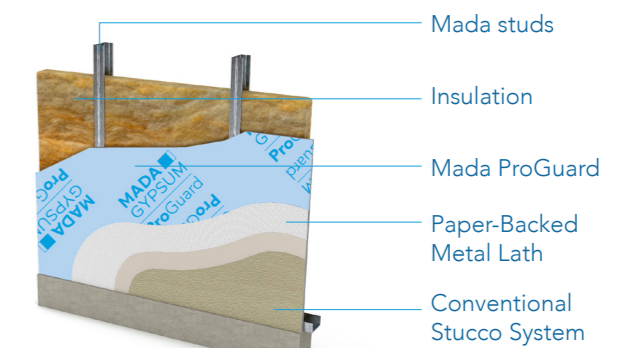

5.6 Sector Specified Details

5.6.1 - Fixing Detail for Additional Attachment

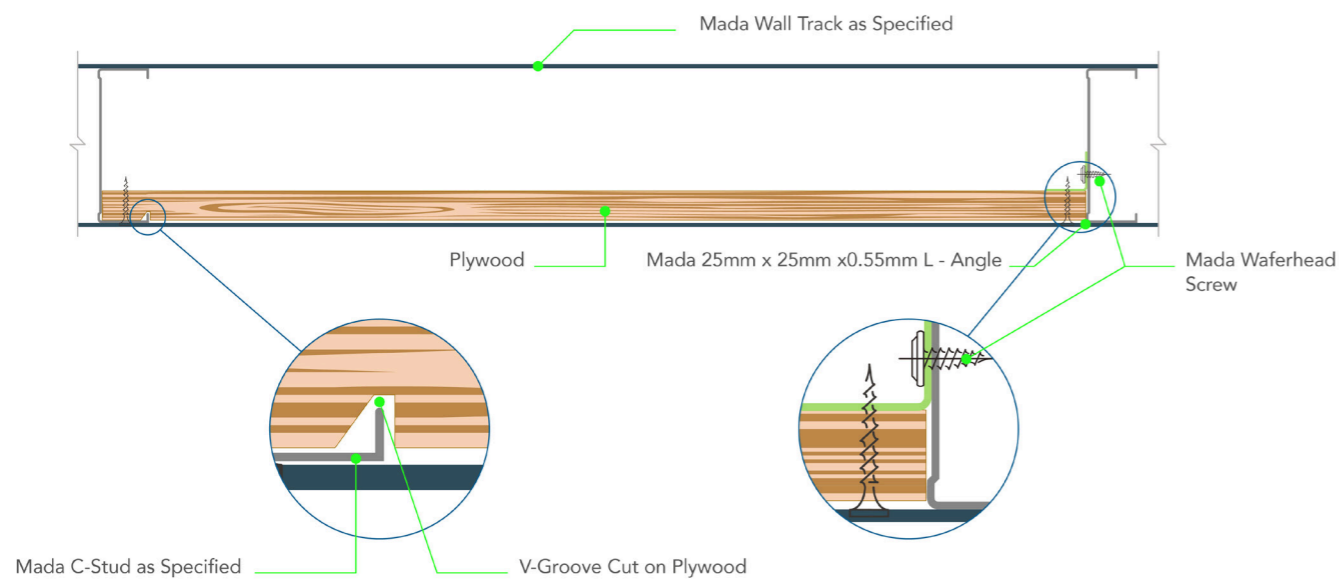

5.6.2 - Plan of Typical Fixing Detail for Electric Switch Box with Putty Pad

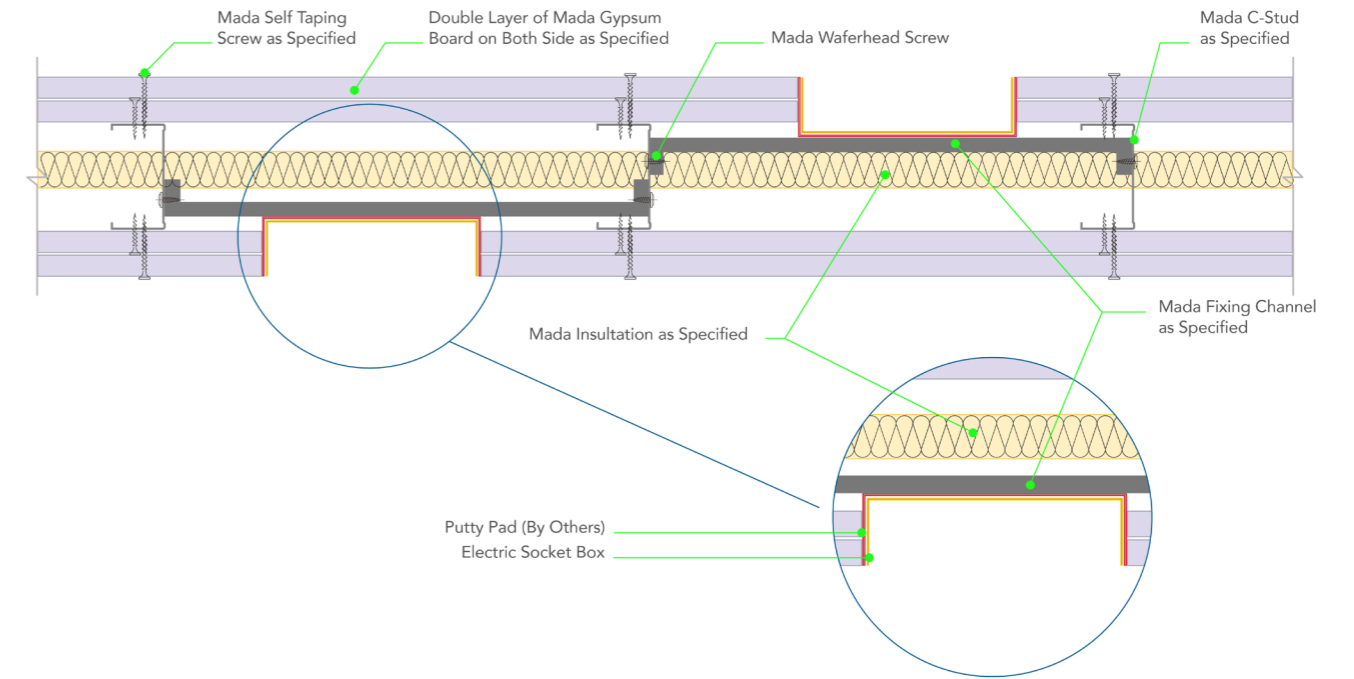

5.6.3 - Plan of Typical Fixing Detail for Electric Switch Box

Electric boxes should be installed offset from each other on the two sides of a partition wall, not back to back.

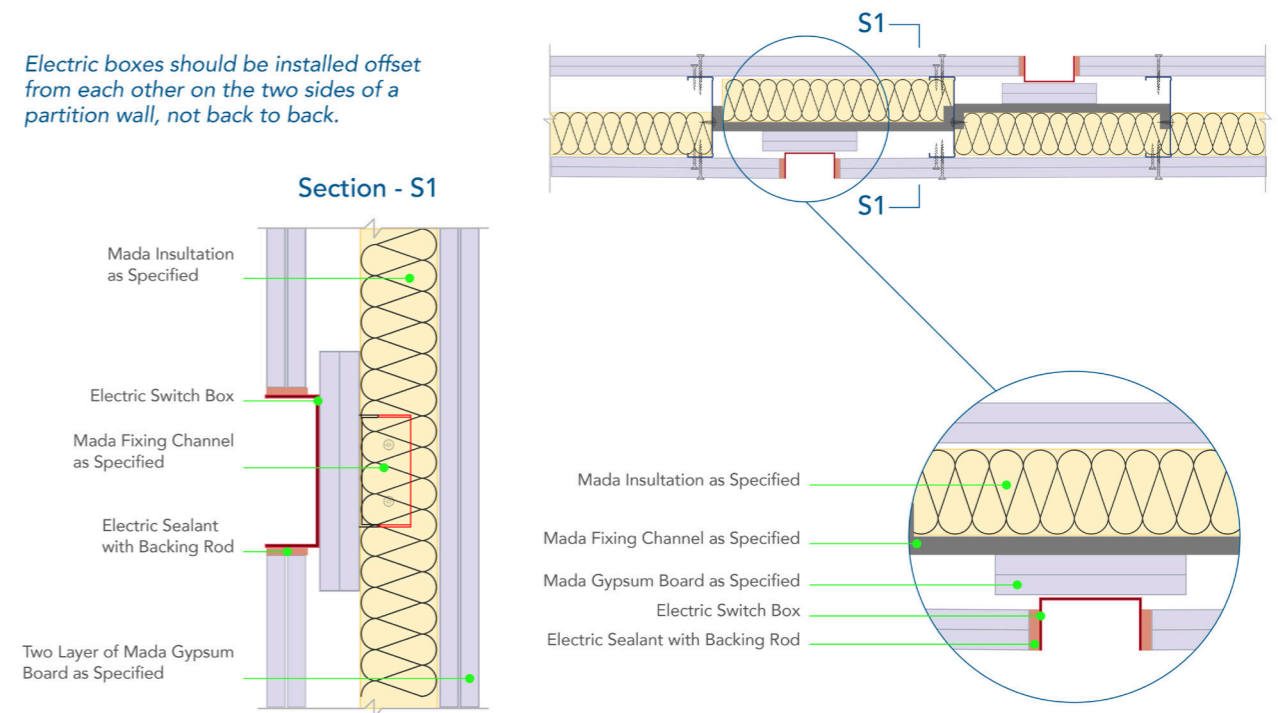

5.6.4 - Standard Door Fixing Details - Up to 25Kg Door Weight

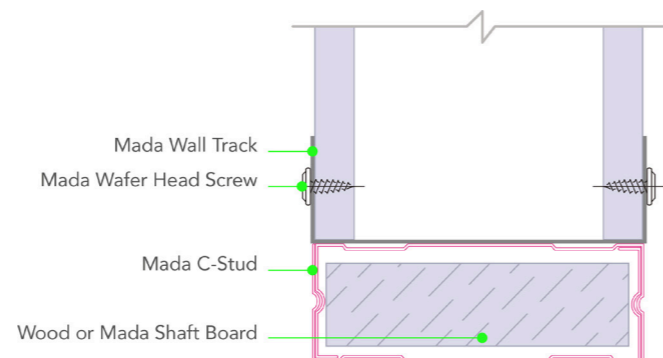
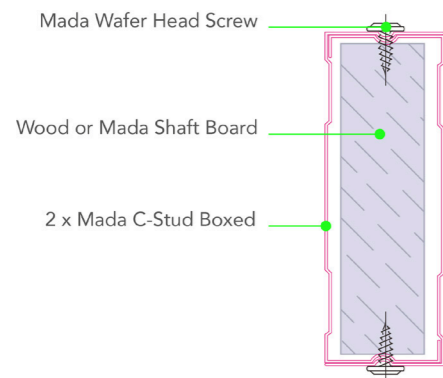
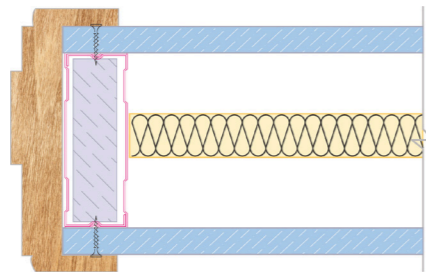
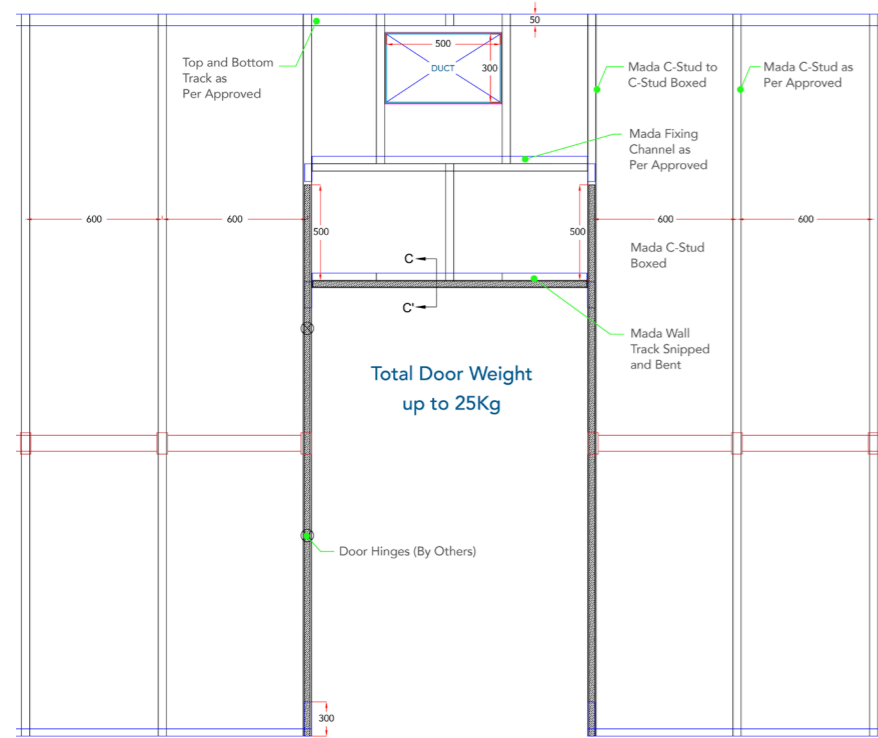

5.7 Finishing and Accessories

Mada offers a wide range of finishing solutions for the Educational Sector, giving additional liability to the performance of the system proposed to benefit from the Mada Warranty:

5.7.1 - Mada Plus Fixings | High quality steel fixings from MADA Gypsum



Mada PLUS Wedge Anchors
Galvanized steel expansion anchors used for fixing hangers, brackets, and drywall profiles to concrete backgrounds.



Mada PLUS Drop-in-Anchor
Drop-In-Anchors are an all-steel, medium duty expansion anchor designed to provide a permanent anchorage point in concrete substrates. An internal thread allows for use with both machine bolts and threaded rod, with no restrictions on fixture thickness.



Mada PLUS Trublot Anchor
Trubolt Stud Anchors are true-to-size, heavy duty, torque-controlled expansion anchors, for permanent anchoring into concrete substrates.



Mada PLUS Plastic Nail Plug
Galvanized steel expansion anchors used for fixing hangers, brackets, and drywall profiles to concrete backgrounds.

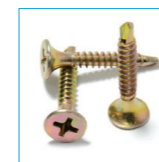

Mada PLUS Drywall Screws
Corrosion-resistant screws with bugle head for fixing plasterboard to metal studs up to a steel thickness of 0.80mm.
Available Lengths
25mm | 35mm | 42mm | 50mm | 62mm

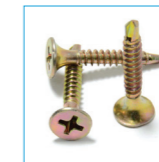

Mada PLUS Self Drilling Screws
Corrosion-resistant screws with bugle head and self-drilling tip for fixing plasterboard to metal studs above 0.80mm thick.

Available Lengths
25mm | 35mm | 45mm | 50mm | 60mm | 65mm

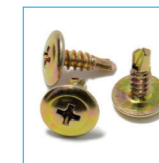

Mada PLUS Wafer Head Screws
Corrosion-resistant screws for fixing metal framing members together.

Available Lengths
13mm

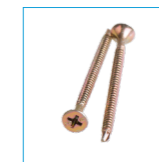

Mada PLUS PROCEM Steel Drill Screws
Corrosion-resistant screws with countersunk head, specially designed ribs under the head and self drilling tip for fixing Mada PLUS PROCEM cement boards to metal studs.

Available Lengths
25mm | 35mm | 45mm | 50mm | 60mm



Mada PLUS Hex Head Self Drilling Screws
Corrosion-resistant screws specially designed for fixing metal to metal with a thickness of 0.8mm up to 3.0mm.

Available Lengths
19mm | 25mm | 50mm

5.7.2 - Mada Plus Finishing Products | High quality, approved finishing products you can trust



Mada Fiber Joint Tape

Mada Fiber Joint Tape is composed of twisted strands of fiber glass woven at right angles to one another and used for reinforcing drywall joints. Suitable for hand or mechanical application with Mada Gypsum's Jointing Compound.



Mada PLUS PROCEM CEMENT Jointing Compound

Mada PROCEM Cement Jointing Compound is a 2-component high-adhesion, high-flexibility jointing material. A powder based on special cement and a secondary, liquid-based, acrylic polymer element with fibers and special additives. Used for jointing and finishing Mada PLUS PROCEM cement board.



Mada Multi-Use Jointing Compound

Mada Multi-Use Jointing Compound contains vinyl binders and other ingredients that provide superior performance compared to ordinary ready mix products. Can be used directly from pail and requires minimal mixing, thinning, and re-tempering.



Mada French Adhesive

Mada French Adhesive is a special gypsum product for adhering decorations and cornices to walls, and the installation of plasterboard on a dot and dab system.

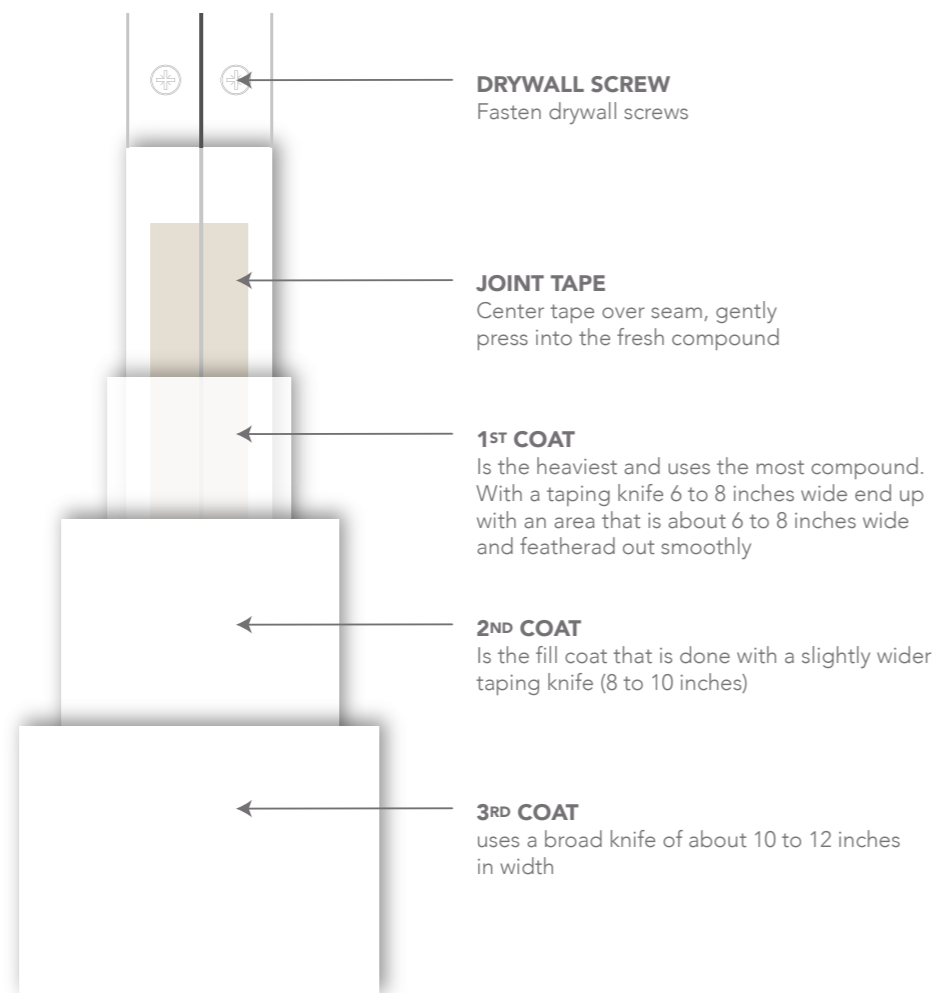

5.7.3 - Mada Plus Approved Insulation | Find the right insulation solution for your project



Glasswool Insulation

An insulating material consisting of fine, long, inorganic fibers bonded together by a high-temperature binder. Excellent acoustic properties, lightweight, high-tensile strength, with exceptional resilience.



Rockwool Insulation

Rockwool is an insulating material manufactured from natural minerals such as basalt, which are melted at very high temperatures and spun using advanced production techniques. The fibers are then bonded with a thermosetting resin binder and special additives. It has good thermal and acoustic properties, is lightweight and strong, and classed as non-combustible when tested to BS:476.

5.7.4 - Mada Plus Accessories | Explore our comprehensive range of accessories



Mada PLUS C-Clamp

Mada C-Clamp is designed to hold the primary ceiling channel to the soffit via threaded rod. This C-Clamp can accommodate 38mm and 45mm Mada Main channels.

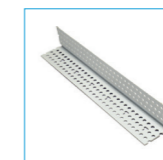

Mada External Corner Beads

Mada External Corner Beads are used for straight, durable, corrosion and impact-resistant protection of the edges and corners of drywall systems.



Threaded Rod

Threaded rods for suspending ceilings. One end fixes to the concrete slab/beams or any other structure with suitable fixings, the other end attaches to the ceiling framework. Designed to be used in high tensions, the thread runs along the entire length of the rod. Available in M⁶, M8 and M10 sizes.



Mada Casin Bead

Mada Casing Beads are squared corner beads that fit firmly over the edge of the plasterboard for protection against impact. A range of casing beads are available to fit different plasterboard thicknesses.

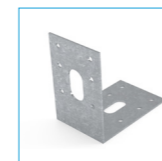

Mada PLUS L-Bracket

Mada PLUS L-Brackets for supporting C-studs at the floor and soffit. Suitable for use in Mada PLUS partitions, Mada PLUS lining systems, and Mada PLUS suspended ceilings.



Mada Shadow Gap Angle Bead

Mada Shadow Gap Angle Bead provides straight and neat finishing details for the internal corners of Mada PLUS suspended ceiling systems.



Mada PLUS Slotted L-Bracket

Slotted L-Brackets are designed to resist high moments and shear due to excessive loading, such as live loads, as well as seismic and wind pressures. Vertical slots on the bracket allow the slab to deflect without impacting the performance or structural integrity of the partition.



Mada PLUS Control Joint Bead

Mada Shadow Gap Angle Bead provides straight and neat finishing details for the internal corners of Mada PLUS suspended ceiling systems.



Mada Sealants

Mada FireGuard Sealant An acrylic-based caulk that is resistant to water and mild chemicals, and contains anti-microbial protection to inhibit the growth of mold and mildew. Mada Fire Guard - Fire and Acoustic Silicone Sealant A single component, neutral cure, elastomeric, gun-grade, high performing fire stopping sealant.

5.7.5 - Renders



Thin Coat Render



Hand Applied Render



Machine Render

Type of render	Grey-white gypsum based render	Grey-white gypsum based render	Render with a glossy surface
Description	Thin coat render with a smooth surface	Render with a smooth surface	Render with a smooth surface
Composition	Stucco, additives to improve adhesion to base material	Stucco, additives to improve adhesion to base material	Stucco, Lime, sand, perlite and additives to improve adhesion to base material
Usage	Interior walls, ceilings at temperatures above 5 °C	Interior walls, ceilings at temperatures above 5 °C	Interior walls, ceilings at temperatures above 5 °C
Workability Time	Manual – < 60 mins	Manual – < 45 mins	Machine – < 120 mins
Coverage	0.9 mm	0.8 mm	1.0 mm
Base surface material	Concrete, Porous Concrete, Render	Brickwork, Concrete, Porous Concrete, Render	Brickwork, Porous Concrete, Render
Recommended render thickness	3 – 6 mm	5 – 30 mm	≥ 6 mm
Surface finish	Paint, Wallpaper	Paint, Wallpaper	Paint, Wallpaper, Tiles
Packaging	40 kg bag	40 kg bag	40 kg bag
Storage term	12 months	12 months	12 months

Head Office: P.O.Box 31542, Yanbu Al Sinayah 51000 Kingdom of Saudi Arabia
Tel.: + 966 14 325 3253 | Fax: + 966 14 325 0420

UAE: +971 4 338 0818 | Bahrain: +966 53 333 0480
Egypt: +20 128 215 3521 | Other Countries: +966 55 536 1370

www.madagypsum.com

Educational Sector

Head Office: P.O.Box 31542, Yanbu Al Sinayah 51000 Kingdom of Saudi Arabia
Tel.: + 966 14 325 3253 | Fax: + 966 14 325 0420